

LEASE OF UNIT FOR COMMERCIAL USE FROM AMAN UDHARES, HULHUMALÉ PHASE 2

Reference No: (IUL)FDC-BD/FDC/2025/5

Date: 22nd January 2025

INVITATION FOR PROPOSALS

LEASE OF UNIT FOR RETAIL USE FROM AMAN UDHARES COMMERCIAL

1. FDC invites capable and interested parties to submit proposals for leasing a commercial unit at Aman Udhares Commercial, designated for the operation of a retail store.
2. The units identified for the project are:
 - **CF01-UDHARES 14 measuring an area of 6788.43 Sqft**
3. Proposals must be submitted no later than **15:00 hrs on 18th February 2025 (Tuesday)**, and must be accompanied by a Bid Security, in accordance with the Instruction to Proponents.
4. Process and schedule of Critical Dates:

Process	Date and Time	Venue and Details
Pre-Proposal Meeting	29 th January 2025, 14:00 hrs	Meeting will be held via Microsoft Teams Link for online Microsoft Teams meeting: Pre-proposal Meeting Link MS Teams
Enquiries	4 th February 2025, Before 14:00 hrs	Enquiries to be submitted in writing or via email: business@fdc.mv
Response to Enquiries	10 th February 2025	Response to the enquiries will be uploaded to FDC corporate website
Submission of Proposal	18 th February 2025, 15:00 hrs	Meeting Room, 1 st Floor, Apollo Towers, Fithuroanu Magu, Hulhumale'
Proposal Opening	18 th February 2025, 15:00 hrs	Meeting Room, 1 st Floor, Apollo Towers, Fithuroanu Magu, Hulhumale'

5. The complete set of Request for Proposal (RFP) documents is available for free download on our website at www.fdc.com.mv. FDC assumes no responsibility for any information not obtained by the Proponent. It is the Proponent's responsibility to verify and ensure they have the latest updates related to this RFP as published on the website.
6. Proponent may obtain further information from the following address:
 - Business Development
 - Fahi Dhiriulhun Corporation Ltd.
 - 6th Floor, Post Building, Boduthakurufaanu Magu
 - Malé Maldives
 - E-mail: business@fdc.mv
 - Tel: (960) 3313244

CONTENTS

SECTION 1– INSTRUCTIONS TO PROPONENTS (ITP)	1
A. GENERAL	1
B. CONTENTS OF RFP DOCUMENTS	4
C. PREPARATIONS OF PROPOSALS	5
D. SUBMISSION AND OPENING OF PROPOSALS	7
E. EVALUATION AND COMPARISON OF PROPOSALS	8
D. AWARDS OF CONTRACT	10
SECTION 2 – RFP DATA SHEET.....	12
A. GENERAL	12
B. CONTENTS OF RFP DOCUMENTS	12
C. PREPARATIONS OF PROPOSALS	12
D. SUBMISSION AND OPENING OF PROPOSALS	13
SECTION 3 – LESSOR’S REQUIREMENTS.....	14
SECTION 4 - QUALIFICATION CRITERIA & EVALUATION	15
SECTION 5 – BUSINESS PROPOSAL REQUIREMENT	17
FORM 01: BID SECURITY FORM	19
FORM 02: LETTER OF PROPOSAL	20
FORM 03: INFORMATION OF THE AUTHORIZED REPRESENTATIVE.....	22
FORM 04: FINANCING METHOD(S).....	23
FORM 05: PROPOSAL CHECKLIST	24
FORM 06: PROPONENTS CHECKLIST	25
FORM 07: DECLARATION OF IMMEDIATE FAMILY MEMBERS.....	27
SECTION 6- CONTRACT TERMS	28
SECTION 7- DRAWINGS AND GUIDELINES	32
1. DRAWINGS.....	32
2. DESIGN AND DEVELOPMENT GUIDELINES.....	33

SECTION 1– INSTRUCTIONS TO PROPONENTS (ITP)

A. GENERAL		
1.	Interpretation of Terms	<p>1.1 The “Lessor”; FAHI DHIRIULHUN CORPORATION, A registered limited liability company with the registration number C03132019, situated on the 1st Floor of the Apollo Towers, Fithuroanu Magu, Hulhumale’, Republic of Maldives, hereby referred to as 'the Lessor,' is releasing this Request for Proposal (RFP). The RFP Data Sheet includes information about the Project's name and Proposal Reference Number.</p> <p>1.2 Within this RFP Documents:</p> <p style="padding-left: 20px;">1.2.1 The term "in writing “pertains to written communication that is sent and anticipated to be received.”</p> <p style="padding-left: 20px;">1.2.2 Unless the context implies otherwise, singular terms encompass the plural, and plural terms encompass the singular; and</p> <p style="padding-left: 20px;">1.2.3 "day" means calendar day.</p>
2.	Fraud and Corruption	<p>2.2 Throughout the RFP process, all parties involved (Proponents, developers, contractors, agents, subcontractors, sub consultants, service providers, suppliers, and staff) are required to uphold impeccable ethical standards by the Lessor. In line with this:</p> <p style="padding-left: 20px;">2.2.1 The Lessor defines "corrupt practice" as attempting to influence FDC Board of Directors and employee’s decision through valuable offerings, and "fraudulent practice" as misrepresenting facts to disadvantage FDC. This includes collusion by Proponents to artificially lower Proposal prices.</p> <p style="padding-left: 20px;">2.2.2 The Lessor retains the right to terminate an award if any recommended Proponent, their associates, subcontractors, service providers, or suppliers engage in corrupt or fraudulent practices during bidding.</p> <p style="padding-left: 20px;">2.2.3 Penalties, including permanent or temporary ineligibility for contracts from the Lessor, may be imposed on companies or individuals. The Lessor can terminate a contract with fourteen (14) days' notice to the Proponent.</p>

3.	Eligibility of Proponents	<p>3.1 Proponent must be a registered legal entity in Maldives (sole proprietorship, partnership, or limited liability company).</p> <p>3.2 If the Section 2 RFP Data Sheet does not specify otherwise, the minimum percentage of equity share required for local partners in a Joint Venture (JV) proposed by Proponents will not be applicable.</p> <p>3.3 A proponent must not have any conflict of interest. If any proponent is found to have a conflict of interest, they will be disqualified. A conflict of interest for the purpose of this RFP process arises if a proponent:</p> <p>3.3.1 Exercises control, directly or indirectly, over another proponent, or is controlled by them, or both share common control.</p> <p>3.3.2 Has received or is receiving financial assistance, whether direct or indirect, from another proponent.</p> <p>3.3.3 Maintains a relationship with another proponent, whether directly or through shared third parties, that could exert influence on the proposal of that proponent or on the lessor's decisions concerning this RFP process.</p> <p>3.4 Submits more than one proposal for a unit in this RFP process via a single business entity. Participation by a proponent in more than one proposal will result in disqualifying all proposals linked to such proponent's involvement.</p> <p>3.5 A Proponent must not be blacklisted by FDC or any government entity.</p> <p>3.6 The Proponent must provide evidence of eligibility as reasonably requested by the Lessor.</p> <p>3.7 Board of Directors, consultants, temporary and permanent employees of FDC are ineligible to submit proposals under this RFP.</p>
4.	Conflict of Interest	<p>4.1 If a Proponent has any personal, financial, social, or technical relationship with any of the below Related Employees of Fahi Dhiriulhun Corporation (FDC), which could directly or indirectly influence the evaluation of their proposal or the Lessor's Request for Proposals (RFP) actions, the Proponent shall be required to disclose such relationships using Form 06 of the RFP.</p> <p>4.2 For the purposes of this Clause, "Related Employees" are defined as:</p> <p>4.2.1 Members of the Board of Directors of FDC.</p> <p>4.2.2 Heads of Senior Management and Heads of Departments responsible for key operational and strategic oversight.</p>



		<p>4.2.3 Heads of Units and Sections supervising specific departments or operational sections within FDC.</p> <p>4.2.4 Assistant Directors, Assistant Managers, and employees above these levels within FDC, holding leadership or decision-making roles.</p> <p>4.2.5 Members of Commercial Evaluation Committees or Ad-hoc Committees involved in proposal evaluation processes.</p> <p>4.2.6 Employees of the Business Development Department, responsible for overseeing commercial procedures at FDC.</p> <p>4.3 Failure to disclose such relationships, or the subsequent revelation of such relationships during the RFP process, may result in the immediate disqualification of the Proponent's submitted proposal.</p> <p>4.4 The Proponent is obligated to disclose, using Form 07, any relationships they or any entity they represent may have with individuals defined as "Related Parties" under these guidelines.</p> <p>4.5 For the purposes of this Clause, "Related Parties" shall include the following:</p> <p>4.5.1 Parents, children, spouse of children, spouse, siblings, or spouse of siblings.</p> <p>4.5.2 Any entity, including partnerships, companies, cooperative societies, sole proprietorships, or other registered businesses or non-governmental organizations, in which any of the aforementioned individuals have a stake exceeding twenty percent (20%).</p> <p>4.6 If a Proponent engages contractors, firms, or consultants deemed "Related Parties" of FDC's Board or employees involved in procurement, prior Board approval is required regardless of contract value. Such relationships must be disclosed during evaluation, and failure to do so may result in disqualification or penalties.</p>
5.	Applicable laws and Courts	5.1 RFP and any resulting contract shall be governed in all respects by the laws of the Republic of Maldives and any litigation with respect thereto shall be brought only in the courts of Maldives.



B. CONTENTS OF RFP DOCUMENTS		
6.	Sections of RFP Documents	<p>6.1 RFP Documents include all the Sections specified below and should be read in conjunction with any addenda issued in accordance with clause 8 of ITP.</p> <p>Section 1. Instructions to Proponents (ITP) Section 2. RFP Data Sheet Section 3. Lessor’s Requirements Section 4. Qualification and valuation Criteria Section 5. Business Proposal Requirement Section 6. Contract Terms Section 7. Drawings and Guidelines</p> <p>6.2 The Lessor is not liable for the completeness of the RFP Documents, answers to requests for clarification, or appendix to the RFP Documents unless acquired directly from the Lessor, according to clause 7 of ITP. In the event of a conflict, documentation acquired directly from the Lessor shall take precedence.</p> <p>6.3 The Proponent is expected to examine all instructions, forms, terms, and specifications in the RFP Documents. Failure to include all information and documents requested in RFP Documents in accordance with clause 6.1 of ITP may result in proposal rejection.</p>
7.	Clarification	<p>7.1 Proponents seeking clarifications regarding the RFP Document should direct their inquiries in writing to the address provided in the Section 2 RFP Data Sheet or during the Pre-proposal Meeting if mentioned in RFP Data Sheet. The proponent’s representative will be invited to this pre-proposal meeting, focused on project details, procedures, clarifications, and addressing queries.</p> <p>7.2 The Lessor will provide written responses to clarification requests received before the specified inquiry deadline in the RFP Data Sheet. These responses will be promptly posted on Lessor’s website. If clarification leads to essential RFP Document changes, the Lessor shall adjust them as per the procedures in clause 8 and clause 19.1 of ITP.</p> <p>7.3 Any required changes to the RFP Documents due to the pre-proposal meeting will be implemented solely through an Addendum, as per clause 8 of ITP.</p>

8.	Addenda	<p>8.1 Prior to the proposal submission due date, the Lessor has the authority to modify the RFP using addenda, either on its own accord or in response to proponent queries. Furthermore, at its exclusive discretion, the Lessor retains the right to extend the proposal submission due date, allowing Proponents a suitable period to adjust to any addendum implications or for other legitimate grounds.</p> <p>8.2 The Lessor holds the authority to modify the RFP Documents before the proposal submission deadline by issuing addenda.</p> <p>8.3 Any introduced amendment must be incorporated within the RFP Documents and promptly made available on Lessor’s website, as per the stipulations outlined in clause 7.1 of ITP.</p> <p>8.4 In order to provide Proponents with an adequate duration to consider the impact of an addendum while preparing their proposals, the Lessor is entitled to extend the proposal submission deadline, as outlined in accordance with clause 19 of ITP.</p>
C. PREPARATIONS OF PROPOSALS		
9.	Cost of Proposal	<p>9.1 The Proponent shall incur all expenses related to the preparation and submission of its proposal, and the Lessor shall not be responsible or accountable for such cost, regardless of the conduct or outcome of the RFP Process.</p>
10.	Language of Proposal	<p>10.1 The RFP should be created in ENGLISH. Additionally, all communication and documents exchanged between the Lessor and Proponent concerning the RFP should also be in English.</p>
11.	Documents comprising the Proposal	<p>11.1 Proposal shall include the following:</p> <p>11.2 Bid Security in accordance with clause 15 of ITP.</p> <p>11.3 Written confirmation authorizing the signatory of the Proposal to commit the Proponent, in accordance with clause 16.2 of ITP and clause 16.3 of ITP.</p> <p>11.4 Business Proposal Requirement stipulated in Section 5.</p> <p>11.5 In the case of a Proposal submitted by a Joint Venture (JV), the JV agreement or letter of intent to enter into JV includes but not limited to scope of works to be executed by respective partners and equity share percentage of the respective partners.</p> <p>11.6 Any other document required in RFP data sheet.</p>
12.	Letter of Proposal	<p>12.1 Utilize Form 2 of Section 5 for the Letter of Proposal. This form must be completed without changes to the text; no substitutions will be accepted. All blanks must be filled with the required information.</p>

		12.2 The Proponent must provide price quotes in compliance with the terms in Section 3 Lessor's Requirement.
13.	Currencies of Proposal	13.1 Any amounts referenced in the proposal shall be stated in either Maldivian Rufiyaa (MVR) or United States Dollars (USD), at the exchange rate of MVR 15.42 per USD.
14.	Validity	14.1 The determination of proposal validity shall adhere to the time frame specified in the Section 2 RFP Data Sheet. The Lessor reserves the right to dismiss any proposal as non-responsive if its validity period is shorter than stipulated.
15.	Bid Security	<p>15.1 The proposal should include an original bid security form, meeting the amount and currency specified in the RFP Data Sheet.</p> <p>15.2 The Bid Security remains valid for the period stated in the RFP Data Sheet.</p> <p>15.3 The bid security must be an unconditional demand guarantee from a locally registered bank or financial institution (e.g., insurance, bonding, or surety firm). Form 01 should be used for this submission.</p> <p>15.4 For Joint Ventures (JVs), the Bid Security must be in the JV's name that submitted the bid. If the JV is not legally formed at the time of the bidding, the Bid Security should include all future members in the letter of intent as per clause 3.1 of ITP and clause 11.1 of ITP.</p> <p>15.5 Proposals lacking a compliant bid security will be rejected as non-responsive by the lessor.</p> <p>15.6 Successful Proponent's Bid Security will be promptly returned after contract signing.</p> <p>15.7 Unsuccessful Proponents will have their Bid Security returned promptly upon the successful Proponent's contract execution.</p> <p>15.8 The Bid Securing Declaration can be invoked if the Proponent withdraws within their proposal's specified timeframe or if the successful Proponent does not fulfill lease deposit payment or comply with conditional award terms by the lessor.</p>
16.	Format and signing	<p>16.1 The Proponent is required to submit an original set of documents supporting the proposal, following the details outlined in clause 18.1 of ITP.</p> <p>16.2 The proposal should be typewritten or in indelible ink on the original and copies. The proposal shall be signed by an authorized representative of Proponent with a confirmed power of attorney/board resolution. Signatories must print their names, titles, and sign on all pages with changes. If the Proponent's organization is a joint venture (JV), the proposal requires the signature of the JV's authorized representative to</p>

		<p>hold legal weight for all members. This authorization should be substantiated by a power of attorney endorsed by these representatives.</p> <p>16.3 Any alterations, deletions, or corrections will only be acknowledged if they are accompanied by the Proponent's signature or initials.</p>
D. SUBMISSION AND OPENING OF PROPOSALS		
17.	Proposal limit	<p>17.1 Each Proponent is strictly limited to submitting a single proposal per unit. Participation in multiple proposals by a Proponent will result in disqualification. If the lessor identifies or suspects collusion among any or all Proponents, the associated proposals will be rejected, and participants engaged in such collusion will be ineligible for future consideration in proposals concerning the same scope of work.</p>
18.	Sealing and marking	<p>18.1 Proposals shall be submitted in person as specified in the RFP Data Sheet. The original proposal document must be enclosed in a sealed envelope clearly marked "ORIGINAL PROPOSAL".</p> <p>18.2 The sealed envelope must contain the following items:</p> <p>18.2.1 The Proponent's name and address, contact number, and contact person.</p> <p>18.2.2 The Commercial Unit number</p> <p>18.2.3 The specified proposal reference number from the RFP Data Sheet.</p> <p>18.2.4 A caution mentioning not to open before the proposal opening date and time.</p> <p>18.2.5 Form 05 – Proposal Checklist.</p> <p>18.3 If the envelope is not properly sealed and marked as stipulated, the Lessor shall not be held liable for any misplacement or premature opening of the proposal.</p>
19.	Deadline for Submission of Proposal	<p>19.1 The proposal document shall be submitted to the address of the Lessor before the Proposal Submission date and time mentioned in the RFP Data Sheet.</p>
20.	Late Proposal	<p>20.1 Any proposals submitted after the submission deadline will not be taken into consideration by the Lessor as specified in clause 19 of ITP. Any proposal received by the Lessor after this deadline will be deemed late and consequently rejected.</p>



21.	Proposal Opening	<p>21.1 Proposals will be opened by the Lessor at the specified address on the date and time indicated in the RFP Data Sheet. This will be done in the presence of Proponent representatives and other attendees.</p> <p>21.2 The Lessor will thoroughly open each proposal one by one and extract and document the following information:</p> <p>21.2.1 The Proponent's name.</p> <p>21.2.2 The presence of the original Bid Security.</p> <p>21.2.3 Proposed lease rate</p> <p>21.2.4 Any other pertinent details as deemed suitable by the Lessor.</p> <p>21.3 Proposals read aloud and recorded during the opening will qualify for evaluation. No proposal shall be rejected unless it is submitted late and if it is not in accordance with the Proposal checklist given in Form 05.</p> <p>21.4 The Lessor will prepare a record of the proposal opening, noting the Proponent's name, lease rate, and bid security status. Proponents' representatives present will sign this record, and copies will be shared with the Proponents.</p>
E. EVALUATION AND COMPARISON OF PROPOSALS		
22.	Right to Verify	<p>22.1 The Lessor retains the authority to review all statements, information, and documents submitted by the Proponent in response to the RFP. The Proponent is obligated, as required by the Lessor, to provide any necessary information, evidence, or documents for verification purposes. The Lessor's verification, or the absence thereof, will not release the Proponent from its obligations or liabilities outlined herein, nor will it impact any rights of the Lessor.</p>
23.	Confidentiality	<p>23.1 Confidentiality shall be maintained concerning proposal evaluation, comparison, and contract award recommendations.</p> <p>This information shall not be disclosed to any party not directly involved in the RFP process, until all Proponents have been duly notified in accordance with Clause 32 of ITP.</p> <p>23.2 Proponent's attempts to influence Lessor's evaluation or award decisions could lead to rejection of their proposal.</p>

24.	Clarification of Proposal	<p>24.1 The Lessor may, as it deems fit, request clarifications from Proponents for proposal evaluation and qualification. Clarifications must be in response to Lessor's requests and provided in writing. Proposal changes, except arithmetical adjustments as per clause 27 of ITP are not permitted.</p> <p>24.2 If a Proponent fails to clarify their proposal by the Lessor's specified deadline, it may result in rejection.</p> <p>24.3 If a Proponent desires to communicate with the Lessor regarding RFP matters between proposal opening and Contract award, it must do so in writing, notwithstanding.</p>
25.	Deviations, Reservations and Omissions	<p>25.1 The subsequent explanations define terms for proposal evaluation:</p> <p>25.1.1 "Deviation" pertains to a departure from the stipulated requirements in the RFP Documents.</p> <p>25.1.2 "Reservation" entails imposing limiting conditions or partial acceptance of the stipulated requirements in the RFP Documents.</p> <p>25.1.3 "Omission" refers to the failure to submit the requested information or documentation in the RFP Documents</p>
26.	Determination of Responsiveness	<p>26.1 The proposal's content, detailed in clause 11.1 of ITP will serve as the foundation for the Lessor's assessment of its responsiveness.</p> <p>26.2 A proposal is deemed substantially responsive when it adheres to the RFP Document requirements with no significant deviations, reservations, or omissions.</p> <p>26.3 A proposal is responsive if it aligns with RFP Document criteria without significant deviation, reservation, or omission. Material deviation, reservation, or omission is when:</p> <p>26.3.1 Acceptance would significantly impact contract scope, quality, or performance, or limit lessor's rights or Proponent's obligations.</p> <p>26.3.2 Rectification could unfairly disadvantage other responsive Proponents.</p> <p>26.4 A proposal that does not substantially meet RFP Document criteria must be rejected by the lessor. Correcting major deviations, reservation, or omission cannot later make it responsive.</p>

27.	Correction of Arithmetical Errors	<p>27.1 The lessor shall address mathematical errors in the proposal according to these criteria, provided the proposal is substantially responsive:</p> <p>27.1.1 If a unit price and the calculated total price differ, the unit price takes precedence, except when an obvious decimal point error is in the unit price, in which case the quoted total price prevails.</p> <p>27.1.2 If a total derived from subtotals has an error, the subtotals take precedence, and the total is corrected.</p> <p>27.1.3 In case of word-number inconsistency, words prevail, unless tied to an arithmetic error; in such cases, figures take precedence, considering (i) and (ii) above.</p> <p>27.2 Proponents shall be requested to acknowledge the correction of arithmetic errors. Failure to accept the correction in accordance with above clause 27.1 of ITP shall result in the rejection of the Proposal.</p>
28.	Evaluation of Proposal	<p>28.1 The Lessor shall apply the criteria and procedures outlined in Section 4.</p> <p>28.2 If the overall assessment score difference among two or more Proponents is below 3%, the proposal with the highest Net Present Value (NPV) among them will be given priority, with the remaining proposals in this range ranked accordingly.</p>
29.	Lessor's right to accept or reject proposals	<p>29.1 The Lessor holds the authority to accept or decline any proposal, annul the RFP process, and reject all proposals before contract award, with no obligation to Proponents. In case of annulment, submitted proposals and bid securities shall be promptly returned to Proponents. Such actions do not impose any liability upon the lessor toward the proponent.</p>
D. AWARDS OF CONTRACT		
30.	Award Criteria	<p>30.1 In accordance with clause 29.1 of ITP, the lessor will conditionally grant the Contract to the proponent(s) whose proposal is found to be substantially compliant with the RFP Documents and achieves the highest score under clause 28 of ITP, provided the Proponent is deemed capable of performing the Contract to a satisfactory standard.</p> <p>30.2 If Section 1 indicates multiple units, the Lessor is obligated to provisionally award the Contract to multiple Proponents.</p>
31.	Unit Selection	<p>31.1 The process of selecting units for the Successful Proponents shall adhere to the procedures outlined in the RFP data sheet.</p>



32.	Notification of Conditional Award	<p>32.1 The Lessor is obligated to notify the successful Proponent in writing about the acceptance of their proposal before the proposal validity period expires.</p> <p>32.2 Prior to the formal contract execution, the proposal acceptance and conditional award notification to the successful Proponents shall serve as a legally binding agreement.</p> <p>32.3 Should the successful Proponent not meet the obligations outlined in the Conditional Award or adhere to contract signing, the Lessor may void the award, and the bid security may be forfeited. In such an instance, the Contract could be awarded to the next ranked Proponent with a substantially responsive proposal.</p>
33.	Signing of Contract	<p>33.1 Upon receiving the conditional award notice, the Lessor must expeditiously provide the successful Proponent with the Contract document.</p> <p>33.2 The successful Proponent must sign the Contract with the Lessor within 7 business days after fulfilling the obligations stated in the Conditional Award Letter.</p>

SECTION 2 – RFP DATA SHEET

A. GENERAL	
ITP 1.1	Name of the RFP: Lease of commercial units from Aman Udhares Commercials For the provision of a Retail Store
ITP 1.1	The RFP Reference is: (IUL)FDC-BD/FDC/2025/5
ITP 3.2	The Joint Venture must have a majority Maldivian shareholder with a minimum of 51% ownership.
B. CONTENTS OF RFP DOCUMENTS	
ITP 7.1	For clarification purposes only, the Lessor's address is: Business Development Fahi Dhiriulhun Corporation. 1st Floor, Apollo Towers, Fithuroanu Magu, Hulhumale’ Tel: (+960)331 3244 E-mail: business@fdc.mv
ITP 7.1	All relevant information regarding the RFP can be found on the official website: https://fdc.mv/
ITP 7.1	The deadline for request for clarification is on or before 4th February 2025 at 14:00hrs
ITP 7.2	The pre-proposal meeting shall take place at the following date, time, and place. Date: 29 th January 2025 Time: Before 14:00 hrs Interested parties can join pre-proposal meeting via Teams link shared on Invitation for Proposals. In order to minimize technical issues please join the meeting 10 minutes prior to the time.
C. PREPARATIONS OF PROPOSALS	
ITP 14.1	Proposal Validity Period: 150 (One Hundred and Fifty) days
ITP 15.1	The Amount and Currency of Bid Security shall be MVR 10,000.00 (Maldivian Rufiyaa Ten Thousand) or equivalent in United States Dollar (USD) . The source of exchange rate shall be Maldives Monetary Authority (MMA) and rate will be determined 14 (fourteen) days prior to the deadline for proposal submission.
ITP 15.2	Bid Security Validity Period: 180 (One Hundred and Eighty) days from the deadline for submission of Proposals.



D. SUBMISSION AND OPENING OF PROPOSALS	
ITP 18.1	The Proponents shall submit the physical documents of the Price Proposal Form and Bid Security to the Lessor's address by the date and time specified in ITP 19.1 below. These documents will not be accepted through any online portal and must be delivered in person.
ITP 19.1	The Lessor's address for proposal submission is: FDC Meeting Room Fahi Dhiriulhun Corporation. 1st Floor, Apollo Towers, Fithuroanu Magu, Hulhumale' Date: 18th February 2025, Time: 15:00 hrs
ITP 21.1	For proposal opening shall take place at: FDC Meeting Room Fahi Dhiriulhun Corporation. 1st Floor, Apollo Towers, Fithuroanu Magu, Hulhumale' Fahi Dhiriulhun Corporation Date: 18th February 2025, Time: 15:00 hrs
	<i>The proposal opening will take place physically in front of the Proponents present.</i>

SECTION 3 – LESSOR’S REQUIREMENTS

1	Scope of Work	Fahi Dhiriulhun Corporation (Lessor) invites interested parties to submit proposals for leasing a commercial unit at Aman Udhares Commercial for the provision of a retail store (RFP Reference No.: (IUL)FDC-BD/FDC/2025/5. The selected party (Lessee) will be responsible for designing, developing, and operating the unit in accordance with the guidelines set forth by FDC for the duration of the lease term.						
2	Business Model	<p>2.1 The Business Model is Lease Model, whereby the Lessee agrees to pay the proposed Lease to the Lessor.</p> <p>2.2 The minimum acceptable lease rate per square feet per month is MVR 40.00 (Maldivian Rufiyaa Forty) for the first five years.</p> <p>2.3 The lease rate proposed for each following year shall be equal to or higher than the previous year's lease rate. Proposed lease rate falls below the lowest allowable lease rate would be rejected.</p>						
3	Estimated Investment Cost	<p>3.1 Estimated Investment Cost for the units is MVR 8,824,959.00 (Maldivian Rufiyaa Eight Million Eight Hundred Twenty-Four Thousand Nine Hundred and Fifty-Nine). This amount is derived based on the unit area, unit usage, and the scope of work essential for the operation of the unit.</p> <p>3.2 The calculation basis for the Estimated Investment Cost is calculated at the rate of MVR 1,300.00 (Maldivian Rufiyaa Thousand) per square feet of the unit with the highest area.</p>						
4	Unit Details	<table border="1" data-bbox="485 1173 1453 1308"> <thead> <tr> <th data-bbox="485 1173 810 1229">Unit Number</th> <th data-bbox="810 1173 1129 1229">Usage</th> <th data-bbox="1129 1173 1453 1229">Unit area (sqft)</th> </tr> </thead> <tbody> <tr> <td data-bbox="485 1229 810 1308">CFO1 – UDHARES 14</td> <td data-bbox="810 1229 1129 1308">RETAIL</td> <td data-bbox="1129 1229 1453 1308">6788.43</td> </tr> </tbody> </table> <p data-bbox="485 1420 1302 1447"><i>Drawings and Guideline related to the unit will be included in Section 7.</i></p>	Unit Number	Usage	Unit area (sqft)	CFO1 – UDHARES 14	RETAIL	6788.43
Unit Number	Usage	Unit area (sqft)						
CFO1 – UDHARES 14	RETAIL	6788.43						

SECTION 4 - QUALIFICATION CRITERIA & EVALUATION

This section defines the standards for Proponent qualification and proposal assessment. In alignment with clause 25 of ITP, no additional factors, methods, or criteria will be considered. Proponents are required to submit all specified information/documents outlined in Section 5, Business Proposal Requirements, ensuring compliance with clause 11.1 of ITP.

1. Qualification Criteria

1.1 Proposals conforming to this Qualification Criteria will undergo evaluation based on the outlined evaluation criteria.

1.2 Financial Resources

- 1.2.1 Proponents shall provide proof of funds to finance the full Estimated Investment Cost by the Lessor as per Lessor's Requirement in clause 3 of Section 3.
- 1.2.2 Financial documents will be evaluated based on the method of funding proposed, and the documents submitted by the Proponents as per clause 4 of Section 5.
- 1.2.3 Proponents who do not show proof of funds to finance the proposed investment cost shall be disqualified.

2. Evaluation Criteria

2.1 Proposals that meet the requirements set in Qualification Criteria of Section 4 will be evaluated based on the following evaluation criteria and points will be allocated as below:

Criteria	Allocated %
Lease Rate	65%
Business Plan	25%
Operational Experience	10%
Total	100%

2.1.1 Lease Rate - 65%

- i. The Lease Rate will be evaluated using the Net Present Value (NPV) of the proposed Lease Rate for the first five years after the grace period. A discount rate of 10% will be applied to calculate the NPV using the formula:

$$NPV = \sum_{n=1}^5 \frac{CF_n}{(1 + R)^n}$$

Where:

- CF_n = Cashflow in year n
(Calculated as **Lease Rate per Square foot x Leasable Area x Payment Period**)
- R = Discounted Rate (10%)
- n = Year (1 to 5)

- ii. Additionally, lease rate proposals will be assessed for outliers to ensure fair evaluation. Outlier calculations are based on the following:

- **First Quartile (Q1):** Represents the 25th percentile of data.
- **Median (Q2):** Represents the 50th percentile of data.
- **Third Quartile (Q3):** Represents the 75th percentile of data.
- **Interquartile Range (IQR):** Calculated as
- **Lower Bound:** $Q1 - 1.5 \times IQR$

- **Upper Bound:** $Q3+1.5 \times IQR$
- iii. Proposals with lease rates falling outside the lower and upper bounds will be considered outliers and disqualified.
- iv. Proponents with the highest NPV will receive the maximum score, and points will be allocated proportionately for other proponents. Proposals that fail to comply with Lessor's Requirements of Section 3 will be disqualified.

2.1.2 Business Plan - 25%

The business plan will be evaluated based on the following criterion:

- i. Marketing Analysis and Strategy - 40 points
- ii. Financial Plan - 30 points
- iii. Management and Operational Plan - 30 points

2.1.3 Operational Experience - 10%

- i. Experience will be assessed based on the number of years spent in a comparable position and the size of the operation.
- ii. Maximum Points for operation experience will be given for registered establishments that have been in operation in a similar operation for the past 5 (five) years and points will be given pro -rata basis for Proponents with less than 5 (five) years operation experience.
- iii. Scale of current operations will be considered based on number of outlets in similar operation. Maximum points for scale of operation shall be given to the Proponents with maximum number of outlets and points will be given pro-rata basis for other Proponents.



SECTION 5 – BUSINESS PROPOSAL REQUIREMENT

In accordance with Section 4 Qualification and Evaluation Criteria, the Proponent must provide the required information in the accompanying documents to establish eligibility for the contract and ensure proposal responsiveness. Proposals should be submitted in the suggested order below, with page numbers and separators for each section.

- 1 Bid Security in accordance with Form 01.
- 2 Letter of Proposal and in Form 02.
 - 2.1 Written confirmation is needed to empower the Proposal signatory for Proponent commitment.
 - 2.2 Utilize Form 02 for the Letter of Proposal. This form must be completed without changes to the text; no substitutions will be accepted. All blanks must be filled with the required information.
 - 2.3 The Proponent must provide price quotes in compliance with the terms in Section 3.
 - 2.4 The proposal's currency should be quoted in Maldivian Rufiyaa (MVR) or United States Dollars (USD).
- 3 Legal Documents
 - 3.1 Business Registration Certificate Copy
 - 3.2 Partnership Deed / Agreement (For Partnerships)
 - 3.3 Memorandum and Articles of Association (For Companies)
 - 3.4 Board Resolution of the Company confirming approval for the proposed work
 - 3.5 Authorized Representative Information as in Form 03.
 - 3.6 Declaration of Immediate Family Members as in Form 07.
 - 3.7 Power of Attorney for signing as of clause 16.2 of ITP.
 - 3.8 For Joint Ventures (JVs): JV agreement or letter of intent, including scope of works and partner equity shares.
 - 3.9 Document showing Proponent ownership and shareholding structure.
- 4 Financial Documents
 - 4.1 Method(s) of Financing as per Form 04: Suggested approach(es) for funding the Estimated Investment Cost and the respective percentage breakdown. The proposed methods for investment funding could encompass equity financing, equity injection, bank financing, external financing from financial firms, credit lines, time deposits, tradeable bonds, or a blend of diverse funding methods.
 - 4.2 Equity Financing by a Sole Proprietorship:

Monthly Average Balance Confirmation of the most recent 12 (twelve) months of the business entity shall be submitted. The submitted statement shall be original, authorized and sealed by the bank/ financial institution.
 - 4.3 Equity Financing by a Company

Monthly Average Balance Confirmation of the most recent 12 (twelve) months of the business entity shall be submitted. The submitted statement shall be original, authorized and sealed by the bank/ financial institution.

 - i. For Company, audited financial statements for past 3 years authorized by a certified audit firm / individual and management account for the year 2023. The audited financial statements must include the auditor's report and shall be signed and stamped by the respective parties. It is not required to submit audited financial statements If the company is not audited as per MIRA requirements.

- 
- 4.4 Bank Financing
 - Bank comfort letter/bank guarantee or any other relevant documents from bank or financial institutions shall be submitted. The submitted documents shall include the Proponent(s) name and name of the proposal with RFP reference.
 - 4.5 External Financing:
 - Letter of commitment from a financier licensed by the central bank and authorized institute with the Proponent(s) name and name of the proposal with RFP reference.
 - 4.6 Credit Information Bureau Report issued from Maldives Monetary Authority for the past 12 months.
 - 4.7 Tax Clearance Report issued from Maldives Inland Revenue Authority
 - i. In any case where the proponent declares to have tax overdue, applicant shall submit repayment flexibility arrangement agreement with Maldives Inland Revenue Authority
 - 5 Business Plan
 - The Proponent needs to present a business plan that incorporates the following components:
 - 5.1 Marketing Analysis and Strategy
 - 5.1.1 Comprehensive marketing analysis involving target market assessment and competitor evaluation.
 - 5.1.2 Marketing strategy encompassing product, price, and promotional strategies.
 - 5.1.3 Detailed description of the Products and Services provided.
 - 5.2 Financial Plan
 - 5.2.1 Financial projection incorporating capital budget, income statement, cash flow analysis, and investment metrics.
 - 5.3 Management and Operational Plan
 - 5.3.1 Management and operational specifics
 - 5.3.2 Resource needs and Human Resources strategy.
 - 5.4 Proposal Checklist
 - 5.4.1 Proposal Checklist as in Form 5 should be attached outside the sealed envelope.

FORM 01: BID SECURITY FORM

The Issuing Bank shall fill in this Bank Security Form in accordance with the instructions indicated.

Issuing Bank: _____ (Bank's Name, and Address of Issuing Branch or Office)

Beneficiary: Fahi Dhiriulhun Corporation Ltd, 6th Floor, Maldives Post Building, Male', Republic of Maldives,

Date: _____

Bid Security No: _____

We have been informed that _____ (name of the proponent) (hereinafter called "the Proponent") has submitted their proposal dated _____ {date of proposal submission} for the execution of _____ {name of project} (hereinafter called "the RFP") under Invitation for Proposal No. _____ {invitation for proposal}.

Furthermore, we understand that, according to your conditions, Proposals must be supported by a Bid Security.

At the request of the Proponent, we _____ {name of Bank} hereby irrevocably undertake to pay you any sum or sums not exceeding in total an amount of _____ [amount in figures] (_____) [amount in words]

upon receipt by us of your first demand in writing accompanied by a written statement stating that the Proponent is in breach of its obligation(s) under the RFP conditions, because the Proponent: Has withdrawn its Proposal during the period of Proposal validity specified by the Proponent in the Letter of Proposal; or

Having been notified of the acceptance of its Proposals by the Employer during the period of Proposal validity, (i) fails or refuses to pay lease deposit, or (ii) fails to execute the term and conditions of the conditional award of the Employer.

This guarantee will expire: (a) if the Proponent is the successful Proponent, upon our receipt of copies of the agreement signed by the Proponent and the lease deposit furnished to you upon the instruction; and (b) if the Proponent is not the successful Proponent, upon the earlier of (i) our receipt of a copy of your notification to the Proponent of the name of the successful Proponent; or (ii) 180 (One Hundred and Eighty) calendar days from {date of submission} of the Proposal for the RFP.

Consequently, any demand for payment under this guarantee must be received by us at the office on or before that date.

This guarantee is subject to the Uniform Rules for Demand Guarantees, ICC Publication No. 758

[seal and signature of the bank/ financial institution]



FORM 02: LETTER OF PROPOSAL

Date: _____
Name of the Commercial Unit: _____
Proposal Reference No: _____

To:

Fahi Dhiriulhun Corporation Ltd
6th Floor, Maldives Post Building, Boduthakurufaanu Magu
Male', Maldives

Declaration

We, the undersigned, declare that:

1. We have examined and have no reservations to the request for Proposal (RFP) documents including all addenda issued in accordance with clause 8 of ITP.
2. We meet the eligibility requirements and have no conflict of interest in accordance with clause 4 of ITP.
3. We have not been suspended nor declared ineligible by the Lessor in accordance with clause 3 of ITP.
4. We have no outstanding payment due to the Lessor in accordance with section 3.
5. We have no non-performance of a contract and non-compliance with court verdicts in accordance with section 3.

We, (insert business name and business registry number), offer to (insert name of Commercial unit).

Proposed Lease Rate

We undertake, to pay the proposed Lease rate for 05 (five) years, where proposal is accepted. The lease rate is:

- 1st Year (per square feet per month): MVR _____ L _____ (amount in numbers)
(Rufiyaa _____ Laari _____) (amount in words)
- 2nd Year (per square feet per month): MVR _____ L _____ (amount in numbers)
(Rufiyaa _____ Laari _____) (amount in words)
- 3rd Year (per square feet per month): MVR _____ L _____ (amount in numbers)
(Rufiyaa _____ Laari _____) (amount in words)
- 4th Year (per square feet per month): MVR _____ L _____ (amount in numbers)
(Rufiyaa _____ Laari _____) (amount in words)
- 5th Year (per square feet per month): MVR _____ L _____ (amount in numbers)
(Rufiyaa _____ Laari _____) (amount in words)

Where the proposal is successful, we undertake to adhere to the Drawings and Guidelines stated in Section 9, during the design and construction of the development / Unit.

Our proposal shall be valid for a period of One Hundred and Fifty (150) days from the date of proposal submission deadline in accordance with RFP document and it shall remain binding upon us and may be accepted at any time before the expiration of that period.

We understand that this proposal, together with your written acceptance thereof included in your notification of award, shall constitute a binding contract between us, until a formal contract is prepared and executed; and



We understand that the Lessor is not bound to accept the highest evaluated proposal or any proposal that the lessor may receive.

Proponent:

Name: _____

(Seal)

Address: _____

Duly authorized to sign the proposal for and on behalf of the Company:

Name: _____

Title: _____

Signature: _____

Date: _____



FORM 03: INFORMATION OF THE AUTHORIZED REPRESENTATIVE

Date: _____

Proposal Reference No: _____

To:

Fahi Dhiriulhun Corporation Ltd.

6th Floor, Maldives Post Building, Boduthakurufaanu Magu

Male', Maldives

This is to authorize (Name, ID number as a representative of (*Name of the Proponent*)) to carry out the Project related to RFP (*ref no*) and to liaise with Lessor on behalf of the (*Name of the Proponent*)

Proponent:

Name: _____

Address: _____

Signature and Stamp

Authorized Representative (preferably fulltime personal):

Name: _____

Designation: _____

ID Number: _____

Contact Number: _____

Email Address: _____

Signature

FORM 04: FINANCING METHOD(S)

Date: _____
Name of the Project: _____
Proposal Reference No: _____

To:
Fahi Dhiriulhun Corporation Ltd
6th Floor, Maldives Post Building, Boduthakurufaanu Magu
Male', Maldives

Where the proposal is successful, we undertake, to finance the project/work through the following methods:

Method of Financing	Percentage Ratio (%)

We hereby confirm and agree to finance the project/work will be financed by the above-mentioned method(s). We have submitted relevant documents to provide proof of funding, to the proposed method(s) of financing the project/work. We understand that the proposal will be disqualified if the documents do not show proof of funds to finance the Estimated Project Cost or if the documents are not in accordance with Section 4. Evaluation & Qualification Criteria clause 1.2 Financial Resources.

Proponent:

Name: _____

Address: _____

Signature and Stamp

FORM 05: PROPOSAL CHECKLIST

Proponents are required to submit Form 05 - Proposal Checklist outside the sealed envelope of the Proposal.

Proponent	For FDC use	
<input type="checkbox"/>	<input type="checkbox"/>	Bid Security as in FORM 01
<input type="checkbox"/>	<input type="checkbox"/>	Letter of Proposal as in FORM 02
<input type="checkbox"/>	<input type="checkbox"/>	Copy of Business Registration Certificate
<input type="checkbox"/>	<input type="checkbox"/>	Board Resolution in SECTION 5 clause 3.4
<input type="checkbox"/>	<input type="checkbox"/>	Proposal Checklist in FORM 05 attached outside seal proposal

NOTE:

PROPOSALS THAT DO NOT INCLUDE THE REQUIRED DOCUMENTS AS SPECIFIED IN FORM 05 - PROPOSAL CHECKLIST (EXCLUDING FORM 05 ITSELF) WILL BE REJECTED AT THE TIME OF PROPOSAL OPENING. BANK STATEMENTS ARE NOT ACCEPTED WITH THE PROPOSAL; ALL REQUIRED FINANCIAL DOCUMENTS MUST BE SUBMITTED AS PER CLAUSE 4 (FINANCIAL DOCUMENTS) IN SECTION 5 - PROPOSAL REQUIREMENT.

FORM 06: PROPONENTS CHECKLIST

Proponents shall confirm that all the required documents are submitted along with the proposals submitted. The Proponents Checklist shall be checked and signed by the Proponent and shall be submitted along with the proposal.

Proposal Documents:	
	Price Proposal Form
	Bid Security
	Business Plan
	Experience documents
Legal Documents:	
Sole Proprietors:	
	Business Registration Certificate
	Information of the Authorized Representative as in Form 03
	Power of Attorney to sign on behalf of the Proponent
Companies:	
	Business Registration Certificate
	Information of the Authorized Representative as in Form 03
	Power of Attorney to sign on behalf of the Proponent
	For Partnership: Partnership Deed / Agreement
	Memorandum and Articles of Association of the Company
	Board Resolution of the Company confirming Board of Director's approval for proposed work
	Document indicating the ownership and shareholding structure of the Proponent.
Financial Documents:	
	Method of Financing Form
Documents required based on the proposed Method of Financing:	
If Equity Financing is proposed:	
	Monthly average balance confirmation of last 12 months and sealed by bank/financial institution
	For companies: Audited Financial statements of the most recent year (2023) or monthly average balance confirmation of last 12 months and sealed by bank/financial institution
If Bank Financing is proposed:	
	Bank Comfort letter
For Equity Injection:	
	Commitment letter from shareholders
	Average monthly balance of the past 12 months authorized and sealed by bank/financial institution of the shareholders (OR) Audited Financial statements of the most recent year (2023) and management account of the year 2024 (OR) Relevant documents for bank financing by shareholder Relevant documents for external financing by shareholder



For external financing:	
	Commitment letter of the financier
	Average monthly balance of the past 12 months authorized and sealed by bank/financial institution of the external financier (OR) Audited Financial statements of the most recent year (2023) and management account of year 2023 (OR) 2024 Relevant documents for bank financing by financier
Business Plan	
	The business plan for the commercial unit lease must include a brief overview of the business operations, details of the products/services offered, marketing analysis and strategy, management and operational plans, and financial forecasts, including investment appraisals and indicators.
<p>We hereby confirm that we have submitted the above-mentioned documents along with the proposal. We understand that the proposal will be disqualified if the documents are not in accordance with Section 5 Business Proposal Requirement.</p> <p>Proponent: Name: _____</p> <p>Address: _____</p> <p>_____</p> <p><i>Signature and Stamp</i></p>	



FORM 07: DECLARATION OF IMMEDIATE FAMILY MEMBERS

Date:

Name of the Project:

Proposal Reference Number:

Proponent Name:

Name of the Authorized Signatory:

We, [*insert business name and business registry number*], hereby confirm and declare that.

has a relation (Immediate family members employed at FDC) that puts in a position to influence the proposal of the proponent, or influence the decisions of the Lessor regarding the RFP process, (Yes/No)

If **YES**, specify the details relating to the information pursuant to Clause 1 above are as follows.

NID No.	Family member/ Relatives Name	Relationship	Position/Title

SECTION 6- CONTRACT TERMS

<p>1. Parties to the Agreement</p>	<p>Fahi Dhiriulhun Corporation Ltd 6th Floor, Maldives Post Building Boduthakurufaanu Magu, Male'</p> <p>(Hereinafter referred to as "Lessor", which expression shall include its successors-in-title, liquidators, administrators, and lawful assignees where the context so requires or admits).</p> <p>[Address of the successful Proponent] (Hereinafter referred to as "Lessee", which expression shall include its successors-in-title, liquidators, administrators, and lawful assignees where the context so requires or admits)</p>	
<p>2. Objective</p>	<p>The objective of this Agreement is to lease the unit for the provision of a Retail store</p>	
<p>3. Unit Detail</p>	<p>Unit No:</p>	<p>Unit Area (Sqft)</p>
<p>4. Unit Usage</p>	<p>The unit should only be used to Operate a Retail store</p>	
<p>5. Lease Term</p>	<p>The lease period is 5 (Five) years from the date of handover of premises.</p>	
<p>6. Business Model & Lease Rate</p>	<p>6.1 The Business Model is Lease model, whereby the Lessee agrees to pay the proposed lease to the Lessor.</p> <p>6.2 The lease rate per square foot per month for the first five years will be the proposed lease rate of the successful Proponent.</p> <p>6.3 The lease rate will be revised after first five years based on market inflation $P(1+i+5\%)$ where, P = monthly lease rate for the preceding year, and I = cumulative inflation for the first five years which will be real estate inflation for the Male' area in the MMA statistics reports.</p> <p>6.4 The lease rate will be effective from the date of unit handover.</p>	
<p>7. Conditions Precedent</p>	<p>7.1 Agreement will only be signed upon fulfilment of the following conditions precedent:</p> <ul style="list-style-type: none"> • Payment of Lease Deposit as per clause 8 of this contract. • Submission of Concept Design and Work Schedule and obtaining approval of Concept Drawing by Lessor as per clause 9 of this contract (if applicable). 	
<p>8. Lease Deposit</p>	<p>8.1 The lease deposit amount shall be 02 (two) months' lease of the lease rate for Year.</p> <p>8.2 This amount should be paid within 07 (seven) working days from the date of the conditional award.</p> <p>8.3 Lease Deposit will be paid back within 60 (sixty) calendar days upon expiration of the Agreement after adjusting for any unpaid lease, penalty, or expenses that Lessor may incur linked to the Agreement and the unit, such as but not limited to unpaid utility bills.</p> <p>8.4 If the Agreement is terminated by the Lessee before the expiration of the</p>	

	Agreement term without the notice period specified under clause 15.7, the Lessor has the right to take the security deposit amount in full.
9. Concept Drawing	<p>9.1 Concept Drawings must comply with the Commercial Design Development Guidelines provided by FDC.</p> <p>9.1 The Concept drawings must be submitted within 20 (twenty) Calendar Days from the receipt of the Conditional Award Letter Date.</p> <p>9.2 The Lessor must inform in writing to the Lessee of the approval of the concept drawing or comments on the concept drawings if any within 14 (fourteen) working days of Submission Date.</p> <p>9.3 If corrections need to be made to the submitted concept drawing, Lessee shall ensure rectifications and submission of the revised concept drawings as per the comments of FDC within 14 (fourteen) calendar days of FDC's comments being communicated, failing to do so will result in annulment of the Conditional Award Letter.</p> <p>9.4 The developer shall address all the issues highlighted in comments provided by FDC for drawings prior to the submission of revised concept.</p> <p>9.5 Revisions to concept drawing cannot be submitted prior to receiving comments from FDC.</p> <p>9.6 Corrections can be made to the concept only up to a maximum of two times.</p> <p>9.7 If the concept is changed / revised and resubmitted for approval, after the initial approval has been given, the lessee will be charged reviewing fee of MVR 5.00 (Maldivian Rufiyaa Five) per square feet.</p>
10. Grace Period	<p>10.1 The first 03 (three) months from the date of Unit handover shall be a grace period where no rent shall be payable by the Lessee.</p> <p>10.2 Additional 1 (one) month of grace period will be granted for units that require demolishing of the partition wall.</p>
11. Unit Handover	<p>11.1 The unit will be handed over to the Lessee within 14 (fourteen) days after signing the Agreement.</p>
12. Option to Renew Term	<p>12.1 The Lessor may at its discretion give the Lessee option to renew or extend the Term, provided that the Lessee requests to renew or extend the Term at least 06 (Six) months prior to expiration of the Term. However, such renewal or extension may be granted based on the Lessee's performance under the Agreement. The Lessor and the Lessee shall negotiate the new extension of the Term. If the Lessor and the Lessee fail to reach mutual Agreement with regard to the terms and conditions for renewal or extension of the Term latest by 03 (Three) months prior to expiration of the Term, then the Agreement shall expire at the end of the Term.</p>



<p>13. Duties and Obligation of Lessee</p>	<p>13.1 Utilize the leased Premises only for the specific usage detailed in Clause 3 and remain consistent in carrying out the work.</p> <p>13.2 The Lessee shall ensure to commence the operation no later than one month from the end of grace period.</p> <p>13.3 The Lessee shall not store any flammable liquids, corrosive materials and/or gas cylinders in the leased space.</p> <p>13.4 The Lessee shall not store any unlawful material or substances (whether in direct or indirect contravention of the laws of the Republic of Maldives) on the Property and shall adhere to the rules and regulations enforced by the Government Authorities.</p> <p>13.5 The Lessee shall not, either intentionally or unintentionally, cause any damage to the property or any other neighboring property or violate any rules and regulations pertained by FDC. Such damage includes, but is not limited to dumping garbage, pollution, unlawful entry, and waste disposal.</p> <p>13.6 The loading and unloading processes shall not cause any disturbances or congestion to any third party.</p> <p>13.7 The Lessee shall not be allowed to make any alteration, changes, replacements, improvements, or additions (any of which is an alteration) in and to the premises at any time, unless approved by FDC.</p> <p>13.8 Use the Premises to provide facilities or services that conform to the rules and regulations and Lessor's guidelines which may be issued and/or modified from time to time, and the rules and regulations enforced by the relevant Authority or any other institution in charge of issuing of permits or authorizations.</p> <p>13.9 Make payments to the relevant Authorities for all utility services consumed or supplied inclusive of electricity meters, water meters and telecommunication connections to the Premises during the Term. The Lessor and the Lessee confirm the readings for the electricity and water supply meters on the Premises at the time of occupation of the Premises.</p> <p>13.10 Not to assign, sublet, charge or part with or share possession or otherwise dispose of the Premises or any of its rights, obligations, or responsibilities under the Agreement without the prior written consent of the Lessor.</p>
<p>14. Duties and Obligation of Lessor</p>	<p>14.1 The Lessor must hand over the unit as per clause 11.</p> <p>14.2 The Lessor Must provide comments on the drawings within 14(fourteen) days of submission of the drawings.</p> <p>14.3 The Lessor should provide all the required information requested by the Developer, without unreasonably withholding or delaying the information. FDC shall not be held responsible for any delay caused which is beyond the control of FDC. Nevertheless, where possible, FDC shall make the best of efforts to minimize the delay.</p>



<p>15. Termination</p>	<p>15.1 The Lessor may serve 30 (thirty) calendar days written notice to the Lessee to terminate the Agreement in the event the Lessee fails to pay the rent and/or penalty as per the terms of the Agreement for a period of 03 (three) consecutive months.</p> <p>15.2 The Lessor may terminate the Agreement without any compensation payable to the Lessee in the event the rent due and/or penalty remains unpaid at the end of 30(thirty) calendar days written notice period.</p> <p>15.3 If the Lessee fails to perform any of its obligation under the Agreement, the Lessee shall be granted a period to rectify the breach along with a fine amount between MVR 5,000 (Maldivian Rufiyaa Five Thousand) and MVR 100,000 (Maldivian Rufiyaa One Hundred Thousand) considering the degree of the breach, to be determined by the sole discretion of the Lessor.</p> <p>15.4 If the Lessee fails to pay the fine and cure the breach within the extension period, the Lessor has the right to terminate the agreement and give the Lessee a duration of not less than 30 (thirty) calendar days to vacate the unit and handover the unit to the Lessor.</p> <p>15.5 The Lessor may terminate the agreement immediately without any prior written notice, if the Lessee fails to perform any of the fundamental obligations.</p> <p>15.6 The Lessor may terminate the Agreement by serving 06 (six) months' written notice upon the Lessee of its intention to do so for any reason whatsoever.</p> <p>15.7 The Lessee may terminate the Agreement by serving 06 (six) months' written notice upon the Lessor of its intention to do so for any reason whatsoever.</p>
-------------------------------	---

DISCLAIMER:

This contract terms only include the key points of the agreement. The agreement is not limited to the clauses included in this contract terms.

The proposal submitted by the successful Proponent shall be a part of the agreement.

SECTION 7- DRAWINGS AND GUIDELINES

1. DRAWINGS

The drawing contains the location map and unit map of the unit to be allocated for the development. Areas in the drawings are subjected to minimal changes.

(Refer to Next page)

CLIENT:

PROJECT:
4000 HOUSING COMMERCIAL
LEASING

DEVELOPER:

REVISION:

PAPER SIZE
A2
DRAFT BY
NAZAN
CHECKED BY
AHMED HASSAAN
STAMP:

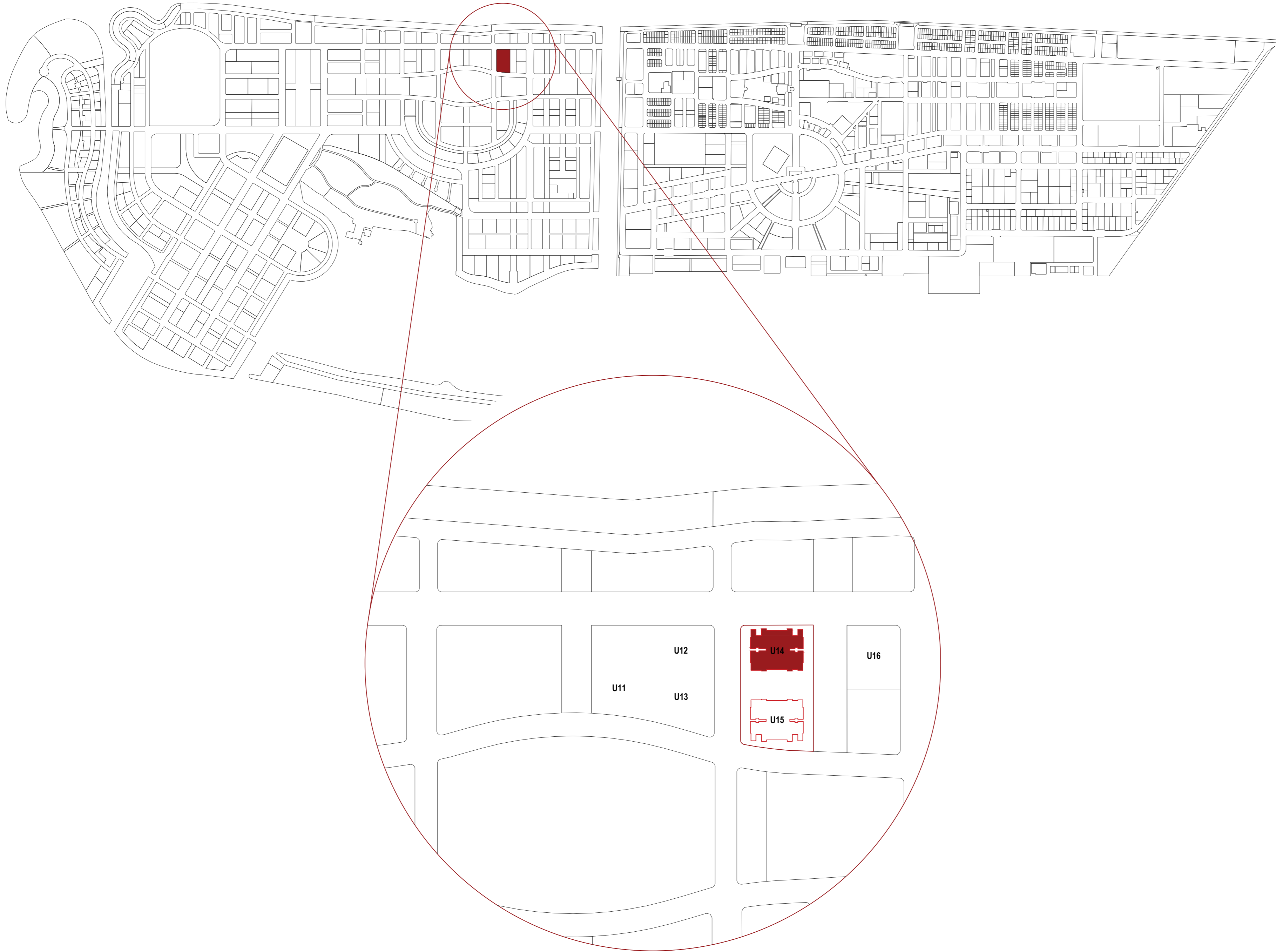

LOCATION MAP

SCALE 1:100



Sheet No.

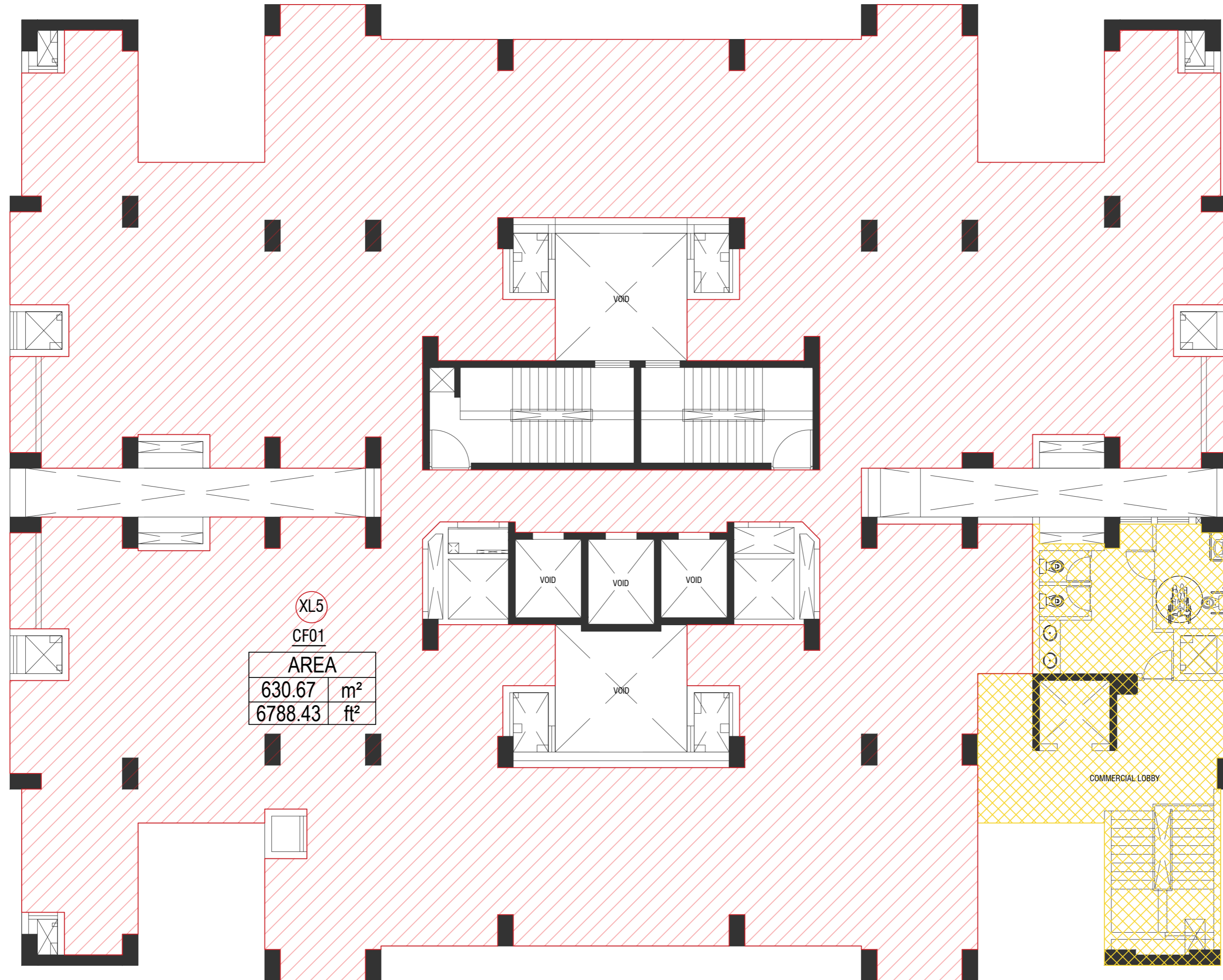

A-01

AMAN UDHARES 14 COMMERCIAL LEASING TYPE 01



BUILDING TYPE	3BHK
FLOOR	FIRST FLOOR
LEASABLE AREA	
CF01	630.67m ²
	6788.43ft ²
COMMON AREA	
	66.53m ²
	716.12ft ²

LEGEND

	COMMON AREA
	LEASABLE AREA

PROPOSED LEASING AREA PLAN

AMAN UDHARES 14 COMMERCIAL LEASING TYPE 01

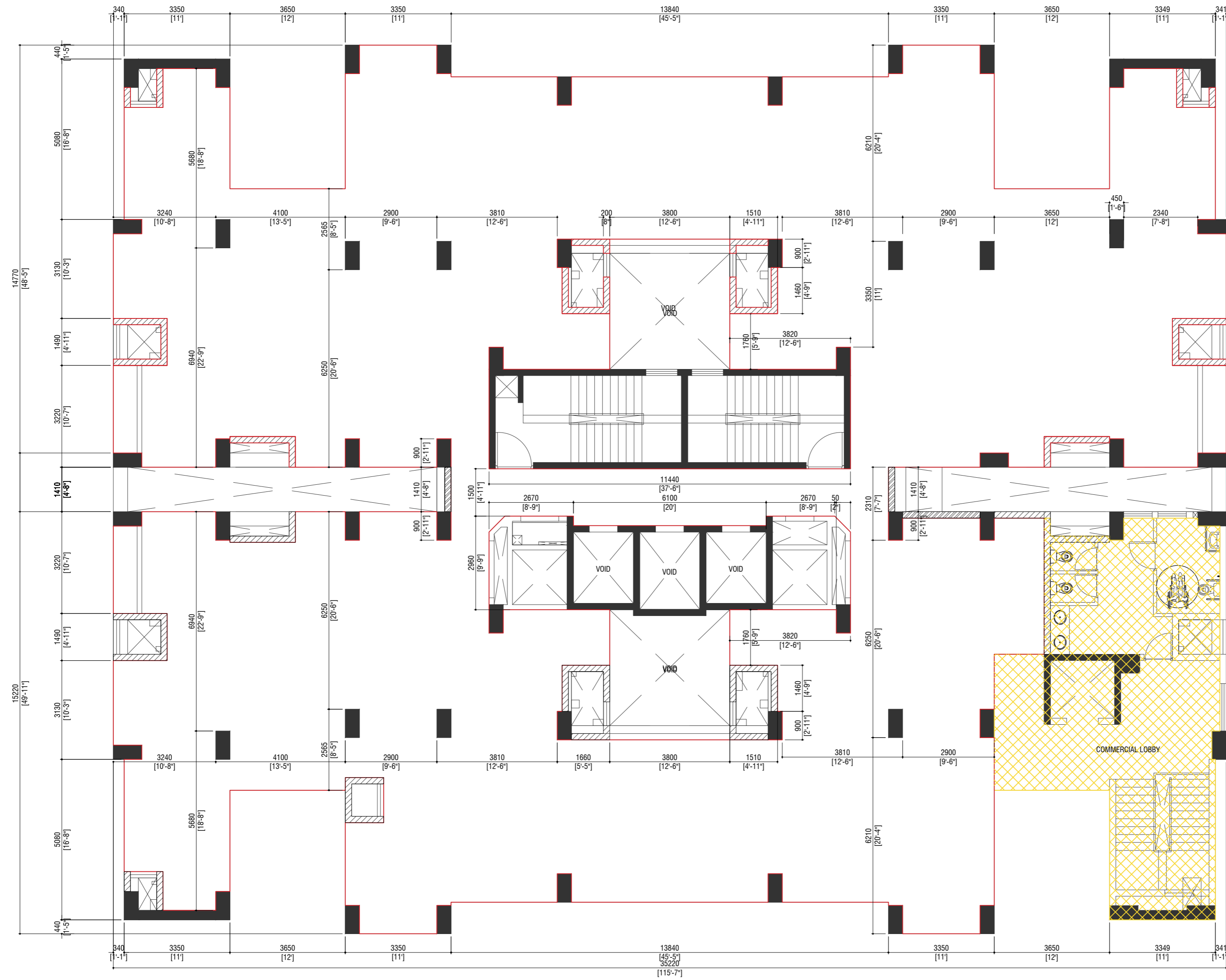

LEGEND
 MASONRY WALL

DIMENSION PLAN



2. DESIGN AND DEVELOPMENT GUIDELINES

(Refer to Next page)



COMMERCIAL DESIGN AND DEVELOPMENT GUIDELINES

i. Introduction

As the developer and custodian of the land, FDC assumes the responsibility to establish the necessary standards and regulations to be maintained in the commercial developments located on the ground and first floor of Aman Flats by FDC.

The Commercial Design and Development Guideline serves as a framework to ensure compliance and maintain a high standard of quality within the commercial development. All tenants must strictly adhere to these guidelines and ensure their full compliance. FDC is vested with the authority to enforce these regulations and take appropriate action if necessary. This authority is granted to FDC to safeguard the interests of the development, its occupants, and the surrounding community, thereby fostering a harmonious and well-maintained environment for all.

This guideline is comprised of two parts:

A. Common Guidelines

Standards and regulations mandatory for all commercial tenants, irrespective of their function.

B. Category Guidelines

Standards and regulations that are applicable, based on the functionality and nature of the tenant’s business. Tenants must refer to the sections that pertain to their respective commercial usage.

B1	Grocery	Applicable to all units operating as grocery stores
B2	F&B	Applicable to all units operating as food and beverage establishments
B3	Institutional	Applicable to all units operating as institutions
B4	Health & Wellness	Applicable to all units that provide health and wellness services
B5	Retail	Applicable to all units operating as retail stores
B6	Community based	Applicable to all units focused on promoting community engagement, social responsibility, and wellbeing of residents



A. Common Guidelines

Standards and regulations mandatory for all commercial tenants, irrespective of their function.



1. General

1.1 Permitted Usage

The commercial units are designated solely for contractually specified mixed-commercial purposes. Strict prohibition is placed on any unauthorized or incompatible use that could jeopardize the safety, functionality, or compliance of the premises. Such prohibited uses encompass residential purposes, including staff accommodation, as well as any industrial activities.

The usage of commercial unit space for ancillary or complementary purposes beyond the permitted use is permissible, subject to approval by FDC. Up to 20% of the total unit area may be designated for such purposes. This allocation must be utilized under the same agreement and cannot be subleased; it must remain under the control of the same tenant.

1.2 Alterations and Modifications to the Structure

The structural system employed in the towers are a shear wall system. Any alteration to the walls or slabs can therefore compromise the structural integrity and longevity of the building.

- It is strictly prohibited to demolish any parts of the existing structure without prior authorization. This includes the slabs, columns, beams and walls.
- Unauthorized cutting of grooves or socket points is not permitted. Tenants must obtain prior approval from FDC and clearly communicate the exact locations for such modifications.
- Cutting out cores on the slab is generally not allowed unless prior approval is obtained from FDC.
- Drilling screws at a depth greater than 25mm is prohibited. In cases where the installation of any material or device requires anchor bolts that necessitate drilling beyond the permissible depth, prior approval must be obtained from FDC.
- Should tenants be found to have carried out prohibited construction work without authorization, they will face legal consequences including potential financial penalties and required restitution

1.3 Common Area

The common areas indicated on ([Annex 01](#)) serve as shared spaces accessible to all commercial tenants and potential customers in the building. These areas encompass the commercial lobby, staircase and elevator, toilets, corridors, loading/unloading locations, waste hold locations and the building maintenance room.

For loading/unloading purposes, FDC will provide a temporary storage location. However, tenants must ensure that the goods are not kept in these locations for prolonged duration.

It is of utmost importance that tenants and their customers demonstrate mutual respect when utilizing these shared spaces. This entails maintaining cleanliness, considering noise levels, ensuring unobstructed passageways, and practicing proper hygiene and sanitation. It is the tenant's responsibility to ensure that their respective customers adhere to these standards. Action can be taken against tenants who fail to oblige.



2. Design and Usage Guidelines

2.1 Accessibility

The following are the minimum requirements for a well-designed, accessible, and safe commercial space that caters to the needs of all.

- The minimum height of the entrance door/opening should be 2.1m.
- Entrance to the commercial units must have a minimum 950mm clear opening.
- If there is a difference of more than 25mm in height between the finished floor level of the entrance corridor and the unit entrance, a wheelchair access ramp with a slope of 1:12 should be provided. This ramp should be provided inside the unit and should be shown in drawings.
- Ramps and slopes should be clearly marked with appropriate markings to indicate their presence and ensure their visibility to individuals with mobility challenges.
- Adequate lighting should be provided both inside and outside the commercial units to ensure optimal visibility and safety for customers and pedestrians.

2.2 Commercial Frontage

In the context of this guideline, the term “commercial frontage” denotes the public space directly adjacent to the commercial unit. It serves as a vital interface between the commercial unit and the public space, creating an inviting and engaging environment while also shaping the character and vibrancy of the streetscape.

- **Allocated Commercial Space:** A designated area measuring 600mm in depth along the width of the commercial frontage will be provided to the commercial unit owner for their business operations. In this space, owners are permitted to install semi-permanent furniture or structures, such as outdoor seating or displays. However, all modifications or constructions in this area must receive prior approval from FDC to ensure they align with local regulations and urban design guidelines.
- **Leasable Area:** This designated space will be considered part of the total leasable area of the commercial unit. The owner can fully utilize it for business purposes, thereby expanding the functional use of the commercial frontage.
- **Development Responsibility:** The commercial unit owner is responsible for the maintenance of the remaining portion of the commercial frontage, or the frontage space directly in front of their respective unit.
- **Maintenance and Upkeep:** The commercial owner is solely responsible for the maintenance and upkeep of their designated frontage area, including any semi-permanent structures or furniture. It is crucial that this space is kept in good condition, clean, and free from damage to uphold the overall aesthetics and functionality of the streetscape.
- **Pedestrian Movement:** The commercial owner must ensure that any developments or structures within this space do not impede pedestrian movement or create any obstructions that may hinder public accessibility. All installations must comply with local safety standards and be positioned in a manner that supports smooth and uninterrupted pedestrian traffic. The owner must avoid any activities that could lead to congestion or hazards, ensuring a safe and welcoming environment for the public.



2.3 Commercial Façade design

Front façade refers to the exterior face of the building that directly faces the main road and is therefore prominently visible from the street. The design considerations should prioritize creating an engaging and lively commercial frontage that enhances the surrounding area.

- All units must display the name of the business along with the address (Unit Number, and Tower number) on the front facade. *(Annex 02)*
- Any business name boards or signage that is fixed on the tower structure can be installed on the designated locations. The dimension of such signage must be 600mm in height and must be limited to the length of the frontage of a given unit *(Annex 02)*
- All signs displayed must be mounted or stamped on a solid backboard. Signage should not be hung or affixed directly to the building façade. This requirement ensures safety and maintains a uniform appearance. *(Annex 03)*
- If the tenant requires a name board to be projected perpendicular to the façade, the board should have a maximum dimension of 600mm x 600mm and be aligned with the level of the commercial signage. *(Annex 04)*.
- Tenants are required to submit the fixing details in cases where there are variations from the standard fixing details provided.

2.4 Lighting and illumination

- The use of lighting and illumination on the façade is permitted if done in a manner that enhances the aesthetic appeal of the building without causing harm or nuisance to others.
- Avoid the use of excessive brightness or glare that may negatively impact neighboring properties, pedestrians, or road users.
- Avoid the use of light fixtures and techniques that increase light spillage and light pollution, especially towards residential areas or public spaces.
- Ensure that lighting installations are designed and positioned in a way that prevents light trespassing onto adjacent properties or areas.
- The use of timers, dimmers, or motion sensors to control the operation and intensity of façade lighting during appropriate hours, preventing unnecessary energy consumption and disturbances during late-night hours is encouraged.

Further regulations regarding design and usage have been provided in the corresponding category guidelines. Tenants must refer to it and adhere to it.

3. Utility and Services

- The requirements of local and statutory authorities with jurisdiction over certain aspects of the works must be followed. These include but are not limited to:

Telecommunication
Water and Sanitation
Electricity
Fire Protection Authority
Food and Drug Authority



- Service areas should be located away from the pedestrian passageways and measures should be taken to screen the views of these areas.
- Storage space within the unit should be effectively managed to fit within the designated unit area and should be clearly indicated on the floor plans.
- All developments must obtain an approved firefighting layout from the Ministry of Defense.
- The layout of each utility network within the development should generally adhere to the established practice of the relevant service provider.
- Any telecom related infrastructure/equipment can be installed on the building with prior approval from FDC.

3.1 Electrical

- Tenants must bear the cost of panel installation and modification after obtaining the necessary approvals from the relevant authorities including FDC before carrying out any physical work on-site.
- The installation of all electrical systems, such as lighting fixtures and electrical outlets, must adhere to the guidelines set forth by the Utility Regulatory Authority of Maldives.
- Given that the commercial units will operate on a three-phase power, it is imperative that all electrical installations adhere to the regulations pertaining to three-phase wiring.
- All electrical wiring, DB, ELCB and meters should be tested (where necessary) and approved by the service providers.
- All conduits should be made of suitable material that is fire-resistant, durable, and appropriate for the intended application.
- All conduits should comply with the electrical safety standards and regulations, including appropriate insulation, grounding, and protection against electrical hazards.
- Conduits should be securely fixed to the wall or surface using appropriate mounting brackets or clamps to ensure stability and prevent accidental dislodgement.

3.2 Plumbing and sanitation

- FDC will provide recommendations regarding the placement and necessary plumbing arrangements for restroom facilities within the designated commercial unit.
- Compliance with the Statutory Regulations and requirements of MWSC is mandatory.
- The discharge of wastewater should be to a sewer network approved by MWSC.
- Tenants must bear the cost of installing oil/grease traps and inspection chambers, where required, after obtaining the necessary approvals from the relevant authorities, including FDC, before carrying out any physical work on-site.

3.3 HVAC and CCTV

- It is highly encouraged to use passive ventilation techniques where possible.
- The design of any air conditioning and/or mechanical ventilation system must adhere to the standards set forth by the American Society of Heating, Refrigerating and Air-Conditioning Engineers (ASHRAE) ([Annex 07](#)).



- Ensure that the brackets used for outdoor installation are suitable for C5-M environment and have no indication of rust.
- Ensure that the AC drainpipes are connected and secured to the provided downpipes, floor drainage or soak pit.
- If a tenant is planning to create a temperature-controlled space, such as a cold storage room or server room, they must ensure it is properly insulated to prevent condensation from affecting adjacent units.
- For such Space tenants must provide detailed information about the intended use and insulation methods for that space, and clearly mark it in the drawings submitted for approval.
- If any damage is caused by the tenant's failure to properly insulate the space, the tenant will be held responsible for rectifying the damage. The tenant must bear the full cost of all necessary repairs and rectifications
- A dome type security camera can be placed on the façade of the given unit. Proposed locations must be indicated on service drawings.
- The location of any form of door operating system must be specified in the drawings.

4. Drawing Approval Process

The drawing approval process comprises of two stages. The first stage is the conceptual drawing stage during which the schematic designs are to be submitted to FDC for approval. FDC will verify whether all the relevant documents have been submitted and issue a submission verification in 2-3 working days. The conceptual drawings will be reviewed to ensure compliance with the design guidelines and overall masterplan of the FDC housing projects. The documents to be submitted to FDC include:

- 4.1 A title block with the following information on each page:
 - Tenant/Company name
 - Commercial Unit ID
 - Function
 - Drawing Title
 - Scale
 - Revision Number
 - Date
- 4.2 As-built plan
- 4.3 Proposed floor plans with the following:
 - Space labels
 - Floor finish levels
 - Furniture layouts
 - Dimensions
- 4.4 Exterior and interior elevations
- 4.5 Minimum 01 section through the unit with floor finished levels and dimensions
- 4.6 Door and window schedule
- 4.7 Material/product specification (if required)
- 4.8 Schematic service drawings



- Electrical layout
- Electrical load calculations (should be submitted for the units which use high voltage such as but not limited to supermarkets, cafes, restaurants, clinics, and must be signed by a relevant registered professional)
- Proposed plumbing layouts (if applicable - fresh water, grey water and WC pipe layout)
- Ventilation layout (AC/exhaust locations and exit points should be marked)
- Waste management plan (if required)

4.9 3D renderings (if required)

Upon receipt of the concept drawing approval, the detailed design can commence. During this stage, tenants will be required to submit the following documents:

- a) Detailed service drawings fit to guidelines set by relevant authorities and approved by them (if approval is required by the relevant authorities)
- b) Ministry of Defense Approved firefighting layout
- c) Concept design approval

FDC will verify whether all the relevant documents have been submitted and issue a submission verification within 2-3 working days. The detailed drawings will then be reviewed by FDC to ensure that all necessary services have been adequately provided. Upon approval, FDC will issue the Detailed Drawing Approval.

Once the detailed drawings are approved by FDC, the documents will be submitted to HDC. From this point onward, the client is responsible for obtaining any additional approvals required by HDC. These approvals must be obtained through the HDC online portal before the construction of the commercial unit can commence.

No physical construction or modification on-site may begin until all approvals from FDC and HDC are obtained, including the 'Building Usage for Commercial Use' Permit

This process is outlined below on the next page.

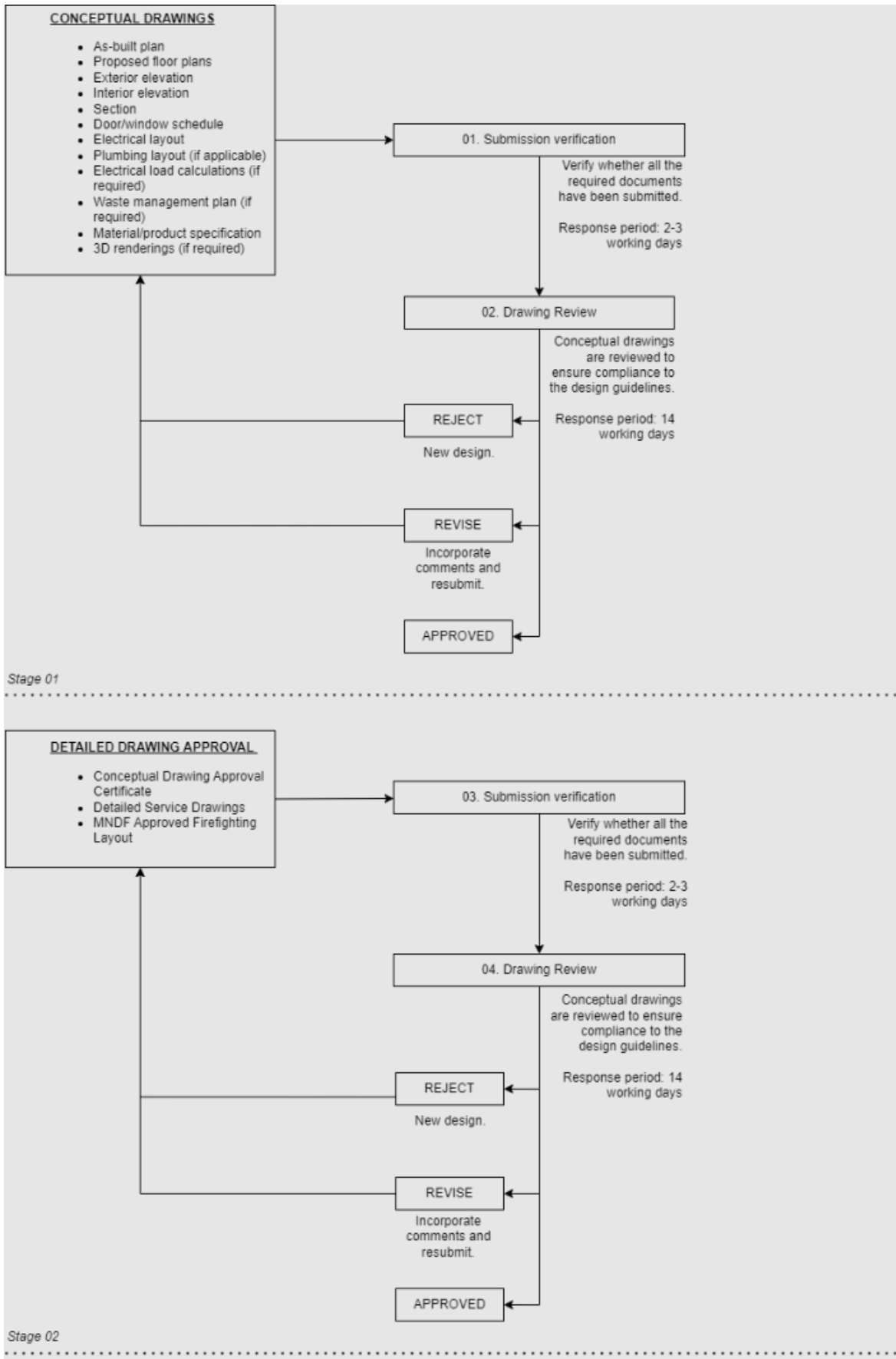



5. Construction Period

To ensure a smooth construction process and minimize disruptions to the surrounding environment, the following guidelines must be adhered to during the construction period.

- Prior approval must be obtained from FDC before commencing any construction work.
- Construction work that generates noise must be carried out between 0800-1800hrs.
- The tenant will be held responsible for any damage incurred to the property and/or its users during the installation/modification of any component of the commercial unit.
- The loading/unloading of construction material must take place in the space allocated by FDC in the parking area. Refrain from parking loading/unloading vehicles in a way that obstructs the traffic flow.
- Construction material must not be placed outside the unit temporarily in a way that impedes the pedestrian or vehicular traffic flow.
- Proper and timely disposal of construction waste is the responsibility of the tenant, who must ensure its appropriate handling and disposal.
- During the construction period, commercial spaces should be enclosed by a fence, which may extend to 600 mm outside the commercial unit. The fence material must be solid and designed to prevent the spread of dust and noise while ensuring the safety of pedestrians and adjacent properties. Materials with perforations, such as mesh nets or agricultural nets, are not permitted.
- Additionally, the tenant is required to cover the entire height of the working area to fully contain any potential construction debris or hazards. The enclosure must provide sufficient protection for the surrounding environment, ensuring that construction activities do not disrupt nearby businesses or public spaces.
- Furthermore, tenants must obtain the necessary municipal permits for the installation of hoarding and fencing during the construction period.

6. Disclaimer

FDC retains the authority to assess and enforce reasonable additional conditions which may not be explicitly addressed in these guidelines. Where appropriate, FDC also maintains the unequivocal right to amend or withdraw any section of this guideline as deemed necessary.

Our utmost priority is the well-being and betterment of the community and as such, we reserve the discretion to exercise flexibility in specific instances to best serve the community's interests.



B. Category Guidelines

Standards and regulations mandatory for all commercial tenants, irrespective of their function.



CATEGORY 1. GROCERY

This section of the guidelines is applicable for groceries such as but not limited to the following:

TYPE	SIZE
Convenience store / corner store / bakery / meat and fish shop	S
General goods	M
Supermarket / fresh produce market	L
Hypermarket / superstore	XL

- It is highly encouraged to provide automated doors. The minimum clear opening of the doors should be 950mm. Ensure that there is sufficient clear space in front of the door.
- Consider factors such as the maneuverability of wheelchairs, turning radius requirements and the elimination of obstructions within the counter area. Avoid obstacles and hazards that may impede accessibility.
- Ensure that only one-third of the front façade is constructed with solid materials that are not transparent. The remaining two-thirds of the front façade should allow for visibility into the commercial space, creating an open and inviting atmosphere.
- When creating a full-height facade, tenants must use tempered glass with a bottom kicker to prevent water entry. If tenants prefer to use float or laminated glass, they must construct a 600 mm high wall to install the glass ([Annex 05](#)).
- A roller shutter door can be used to close at the end of business hours.
- Provide adequate lighting through the grocery and retail units and ensure visibility of products and pathways.
- Supermarkets, superstores and hypermarkets should provide clear and visible signage to guide customers to different sections, departments and amenities.
- It is strictly prohibited for any commercial activities, including the placement of display racks or similar objects to extend beyond the unit into pedestrian passageways and common areas.
- Wet sections should be of non-slip surface and should be well drained.
- Refrain from parking loading/unloading vehicles in a way that obstructs the traffic flow.
- Measures should be taken to minimize potential heat, noise and odor impact on neighboring properties or public spaces. Utilize appropriate noise reduction techniques such as insulation, acoustic panels and air filters.
- All waste should be managed within the unit.



CATEGORY 2. FOOD AND BEVERAGE

This section of the guidelines is applicable for food and beverage (F&B) establishments such as but not limited to the following:

TYPE	SIZE
Hedhikaa stalls / juice bar/ food kiosk	S
Specialty coffee shop / cafe	M
Restaurant	L
Food court	XL

- Ensure that only one-third of the front façade is constructed with solid materials that are not transparent. The remaining two-thirds of the front façade should allow for visibility into the space creating an open and inviting atmosphere.
- When creating a full-height facade, tenants must use tempered glass with a bottom kicker to prevent water entry. If tenants prefer to use float or laminated glass, they must construct a 600 mm high wall to install the glass ([Annex 05](#)).
- A roller shutter door can be used to close at the end of business hours.
- Two out of every ten tables or a minimum of at least two tables should be wheelchair accessible. (Should be marked on drawing) These accessible tables can have a maximum of 50% of their seats fixed in place, while the remaining seats should be loose. In cases where the establishment utilizes fixed seats, there must be a minimum clear space of 750mm measured along the table as illustrated in Figure B.

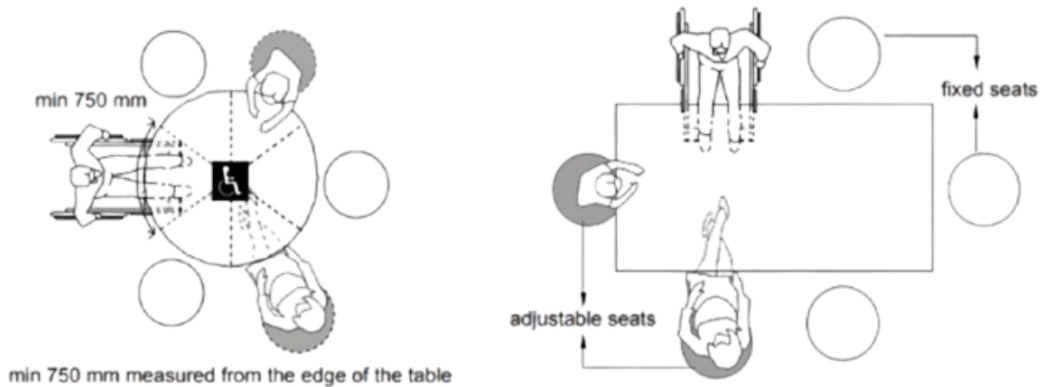

Arrangement of Tables and Seats in Food Court

Figure B

- Adequate baby chairs with side and backrests and a safety belt or T-bar should be provided. These should be stable and preferably portable.
- It is highly advised and encouraged to use the commercial frontage as an accessory space of F&B establishments as per ([Annex 01](#)). However, it is essential that these areas are used by customers and non-customers alike.



- The commercial frontage space should be visually appealing. The furniture used in the commercial frontage space should be tasteful and not detract from the overall appearance of the public space.
- Tenants must ensure the cleanliness of the frontage space.
- Sun-shading devices such as awnings, canopies, pergolas, shade sails and retractable umbrellas can be used within the commercial frontage. These structures should be temporary in nature, allowing for easy installation and dismantling, and must be constructed within the specified designated area.
- The minimum clear height of any such structure should be 2.1m while the maximum height to the top-most edge of the structure should be 3.9m. The fixing details of such structures should be provided at the drawing approval stage.
- Furniture such as loose tables, chairs and benches can be placed within the commercial frontage, as outlined in the provided drawing ([Annex 01](#)). However, encroachment of such upon other areas or obstruction of pedestrian movement is strictly prohibited.
- The minimum height of any railing, parapet wall or similar on the first-floor level should have a minimum height of 1.2m. The materials used must be durable and structurally sound to withstand applied loads. The design must prevent climbing and should not have any gaps larger than 125mm ([Annex 06](#)).
- Outdoor kiosks for food preparation can be allowed. However, no major food preparation such as grilling, frying and baking is allowed in such areas.
- Food stalls, kiosks and takeaway counters should ensure that the queues for such services do not hinder pedestrian movement on the sidewalk.
- Food stalls, kiosks and takeaway counters should take proactive measures to prevent littering by providing dustbins for customers to dispose of their waste properly.
- Any smoking areas must have proper ventilation and should not be towards pedestrian passageways. Smoking areas on the first floors are prohibited unless mechanically ventilated. Such systems should discharge away from pedestrian pathways.
- Each kitchen unit must be equipped with a commercial kitchen hood and exhaust system as per the ASHRAE standards. An appropriate grease and odor filter must be fitted. The location of the exhaust unit and exit must be clearly indicated on the service drawings and submitted for approval. Kitchen exhaust exit cannot face or discharge directly into pedestrian passageways.
- Measures should be taken to minimize potential heat, noise and odor impact on neighboring properties or public spaces. Utilize appropriate noise reduction techniques such insulation, acoustic panels, or strategic placement of kitchen equipment.
- Refrain from parking loading/unloading vehicles in a way that obstructs the traffic flow.
- Dry waste should be managed within the unit.
- A designated wet waste management area must be provided in the unit with multiple bin space for waste segregation and should be shown on the drawing. All bins utilized for wet waste must have lids to ensure proper containment.
- Ensure compliance with local health and safety regulations, including proper food handling, ventilation and gas cylinder handling.



CATEGORY 3. INSTITUTION

This section of the guidelines is applicable for institutional activities such as but not limited to the following:

TYPE	SIZE
ATM / Utility kiosk / Office space	S
Tuition class / Qur'an class / Arts and Crafts Studio/ Daycare/ Office Space	M & L
Tuition center / Pre-school / Qur'an Institute / Art Gallery / Office Space / Bank branch	XL

- Relevant laws and guidelines pertaining to the type of institutional activity must be followed.
- The façade design must consider the activities taking place within the unit. It is highly discouraged to incorporate blind walls in the façade as they obstruct the interaction between the building and the surrounding public realm.
- Measures should be taken to minimize potential noise and odor impact on neighboring properties or public spaces. Utilize appropriate noise reduction techniques such as insulation and acoustic panels.
- Provide signage prominently displayed outside the unit to guide visitors and ensure clear navigation. Where appropriate, provide contact information and opening/closing hours clearly.
- Refrain from parking loading/unloading vehicles in a way that obstructs the traffic flow.
- All waste should be managed within the unit.
- If any wet waste is generated, a designated wet waste management area must be provided in the unit with multiple bin space for waste segregation and should be shown on the drawing. All bins utilized for wet waste must have lids to ensure proper containment.



CATEGORY 4. HEALTHCARE AND WELLBEING

This section of the guidelines is applicable for health and well-being related establishments such as but not limited to the following:

TYPE	SIZE
Clinic / Gym / Aerobics Center / Yoga Center / Fitness and Wellness Center / Spa / Salon	M & L
Medical Center	XL

- Medical centers and clinics must adhere to the design guidelines and regulations established by the Ministry of Health of Maldives.
- The façade design must consider the activities taking place within the unit. It is highly discouraged to incorporate blind walls in the façade as they obstruct the interaction between the building and the surrounding public realm.
- All accessways and circulation paths must have a minimum width of 1200mm to allow ease of wheelchair access.
- Measures should be taken to minimize potential heat, noise and odor impact on neighboring properties or public spaces. Utilize appropriate noise reduction techniques such as insulation and acoustic panels.
- Provide signage prominently displayed outside the unit to guide visitors and ensure clear navigation. Where appropriate, provide contact information and opening/closing hours clearly.
- Refrain from parking loading/unloading vehicles in a way that obstructs the traffic flow.
- If any wet waste is generated in the unit, a designated wet waste management area must be provided in the unit with multiple bin space for waste segregation and should be shown on the drawing. All bins utilized for wet waste must have lids to ensure proper containment.
- All waste should be managed within the unit.
- If any biohazardous waste is generated in the unit, it must be discarded properly as per the Ministry of Health regulations and standards.



CATEGORY 5. RETAIL OUTLETS

This section of the guidelines is applicable for retail outlets such as but not limited to the following:

TYPE	SIZE
Small retail outlets	S
Medium retail outlets	M
Large retail outlets	L
Department Store model retail outlets	XL

- The minimum clear opening of the doors should be 950mm. Ensure that there is sufficient clear space in front of the door.
- The choice of material for the façade of the units must allow clear visibility into the commercial activities taking place inside the store from the surroundings.
- It is strictly prohibited for any commercial activities including placement of display racks or similar objects to extend beyond the unit into pedestrian passageways and common areas.
- Refrain from parking loading/unloading vehicles in a way that obstructs the traffic flow.
- Dry waste should be managed within the unit.
- If any wet waste is generated in the unit, a designated wet waste management area must be provided in the unit with multiple bin space for waste segregation and should be shown on the drawing. All bins utilized for wet waste must have lids to ensure proper containment.



CATEGORY 6. COMMUNITY-BASED UNITS

This section of the guidelines is applicable for community-based establishments such as but not limited to the following:

Co-working & incubator / SME Hub / Youth Center

- The façade design must encourage engagement between the building and the surrounding public realm. Consider incorporating interactive features that allow users to control or manipulate elements of the façade, creating a sense of agency and involvement.
- It is highly advised and encouraged to utilize the commercial frontage in a way that encourages interaction and engagement.
- The commercial frontage space should be visually appealing. The furniture used in the commercial frontage space should be tasteful and not detract from the overall appearance of the public space.
- Tenants must ensure the cleanliness of the frontage space.
- Sun-shading devices such as awnings, canopies, pergolas, shade sails and retractable umbrellas can be used within the commercial frontage. These structures should be temporary in nature, allowing for easy installation and dismantling, and must be constructed within the specified designated area.
- The minimum clear height of any such structure should be 2.1m while the maximum height to the top-most edge of the structure should be 3.0m. The fixing details of such structures should be provided at the drawing approval stage.
- Furniture such as loose tables, chairs and benches can be placed within the commercial frontage, as outlined in the provided drawing ([Annex 01](#)). However, encroachment of such upon other areas or obstruction of pedestrian movement is strictly prohibited.
- Any pedestrian passageway should have a minimum of 1200mm to allow both a wheelchair and a person to pass.
- Provide adequate lighting through the grocery and retail units and ensure visibility of products and pathways.
- The minimum height of any railing, parapet wall or similar on the first-floor level should have a minimum height of 1.2m from the finished floor level.
- Measures should be taken to minimize potential heat, noise and odor impact on neighboring properties or public spaces. Utilize appropriate noise reduction techniques such insulation, acoustic panels, or strategic placement of equipment.
- Provide signage prominently displayed outside the unit to guide visitors and ensure clear navigation. Where appropriate, provide contact information and opening/closing hours clearly.
- Dry waste should be managed within the unit.
- A designated wet waste management area must be provided in the unit with multiple bin space for waste segregation and should be shown on the drawing. All bins utilized for wet waste must have lids to ensure proper containment.

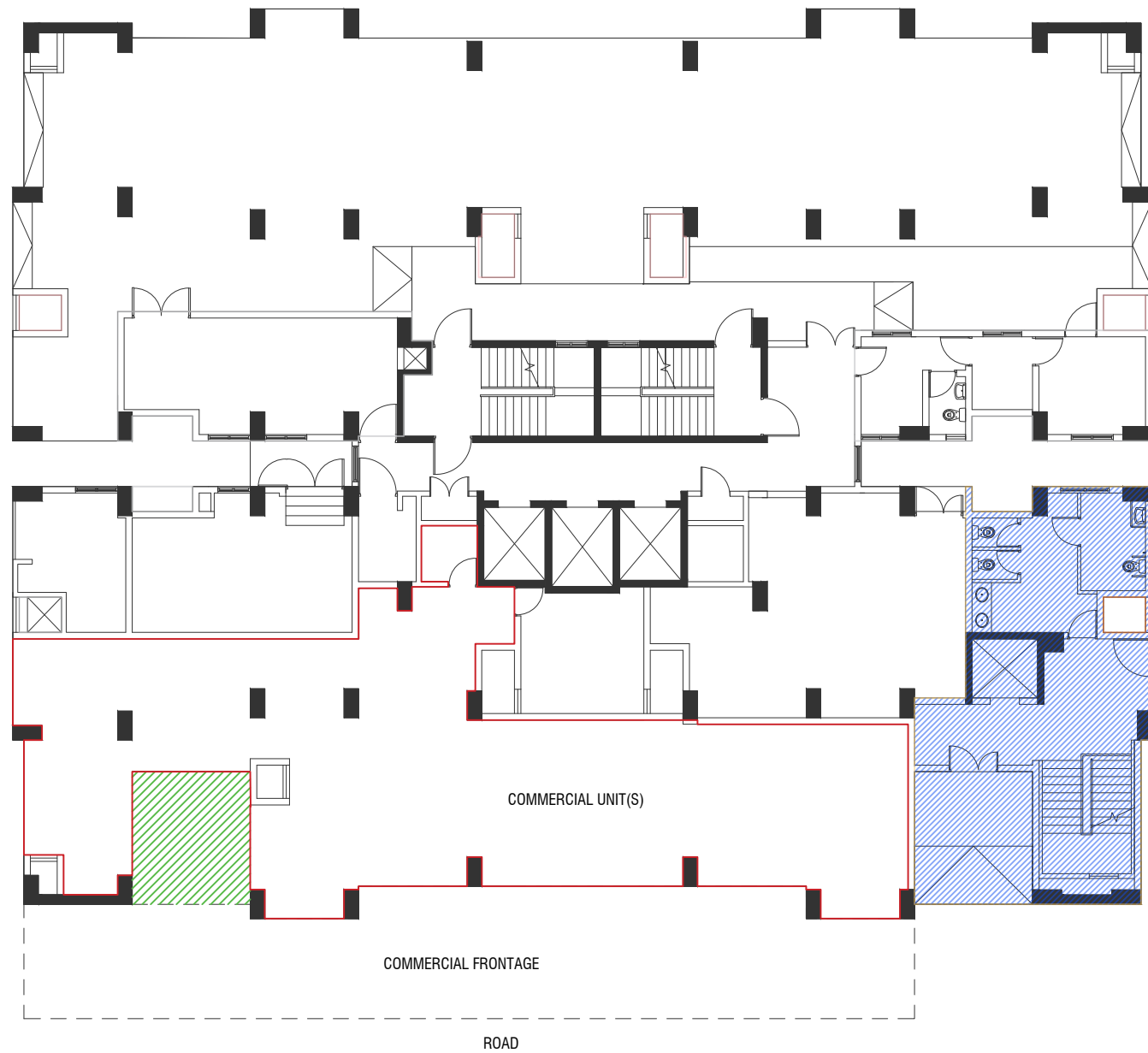

UDHARES 3BHK GROUND FLOOR PLAN
HULHUMALE' | PHASE 02

-  UNIT AREA
-  COMMON AREA
-  ACCESSORY AREA

UNIT LOCATION PLAN

SCALE 1:200

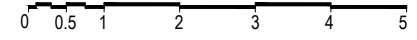

FAHI DHIRIULHUN CORPORATION LTD
POST BUILDING | 6TH FLOOR | 20026
BODUTHAKURUFAANU MAGU | MALE'
TEL: 3313244 | MAIL: planning@fdc.mv

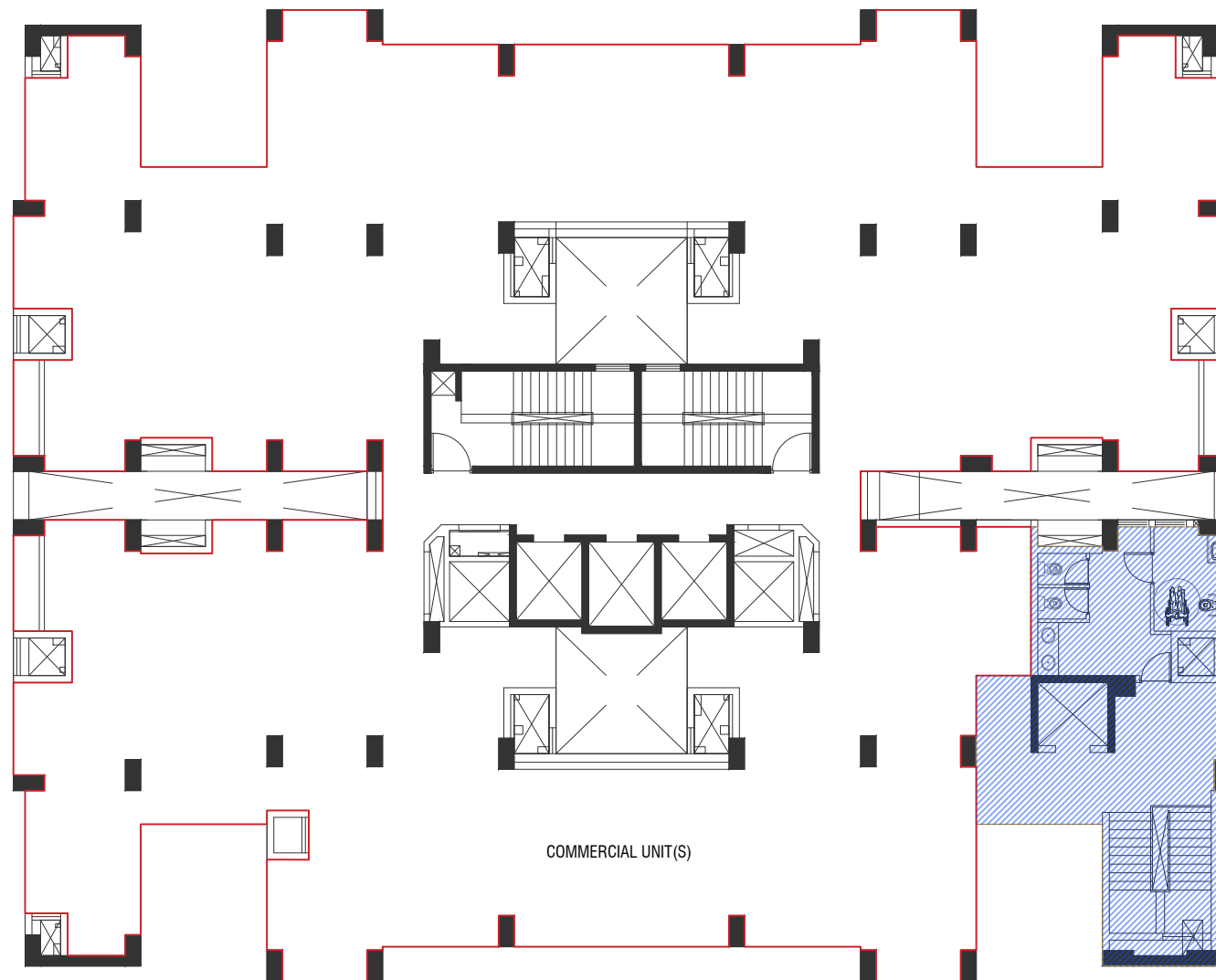

UDHARES 3BHK FIRST FLOOR PLAN
HULHUMALE' | PHASE 02

-  UNIT AREA
-  COMMON AREA
-  ACCESSORY AREA

UNIT LOCATION PLAN

SCALE 1:200



FAHI DHIRIULHUN CORPORATION LTD
POST BUILDING | 6TH FLOOR | 20026
BODUTHAKURUFAANU MAGU | MALE'
TEL: 3313244 | MAIL: planning@fdc.mv

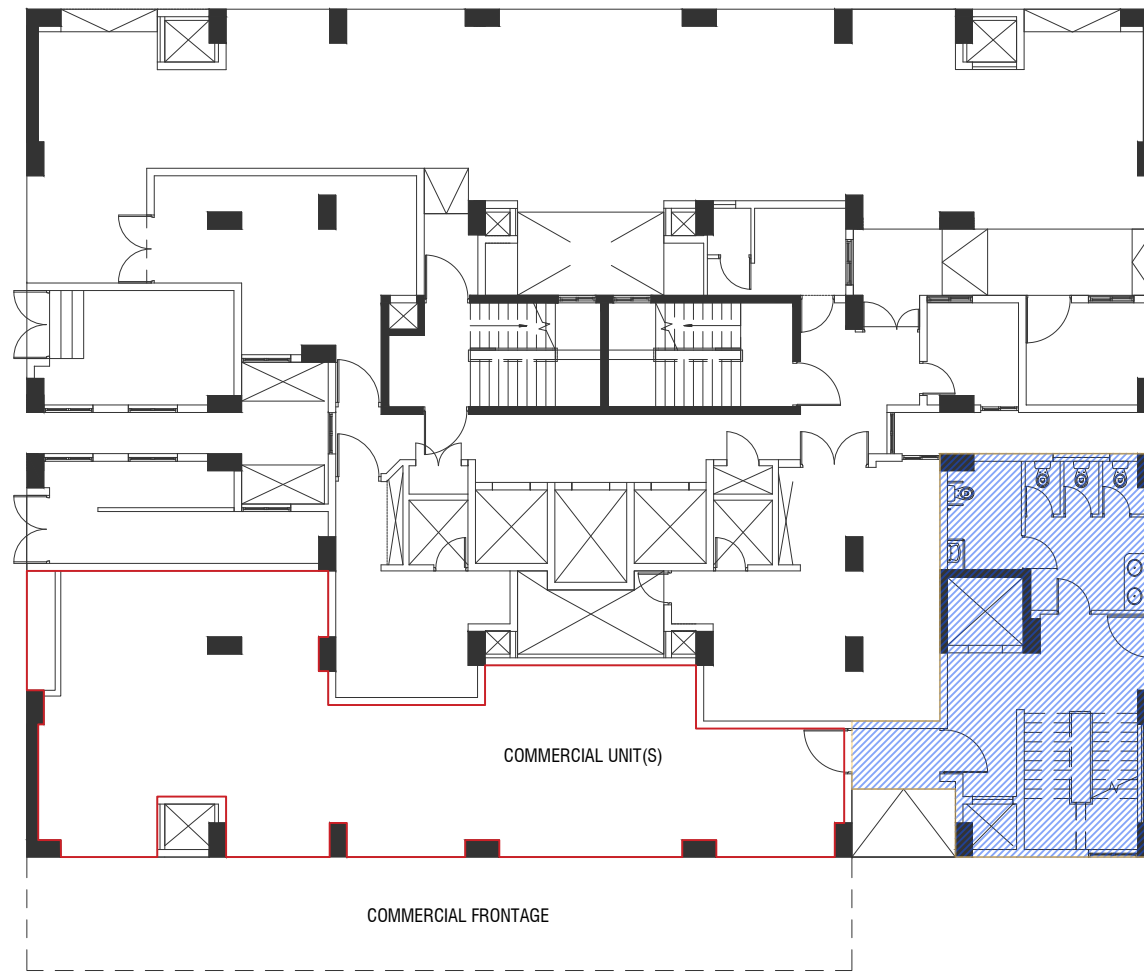

UDHARES 2BHK GROUND FLOOR PLAN
HULHUMALE' | PHASE 02

-  UNIT AREA
-  COMMON AREA
-  ACCESSORY AREA

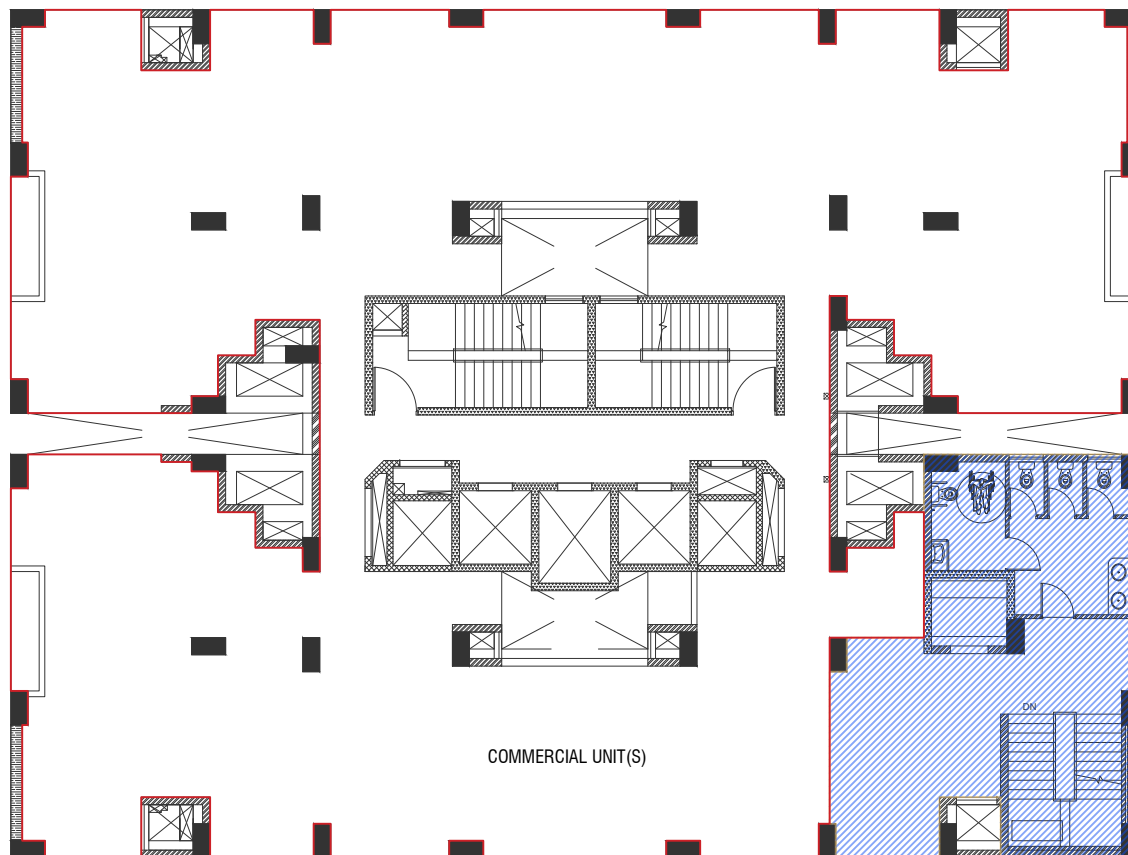

UDHARES 2BHK FIRST FLOOR PLAN
HULHUMALE' | PHASE 02

-  UNIT AREA
-  COMMON AREA
-  ACCESSORY AREA

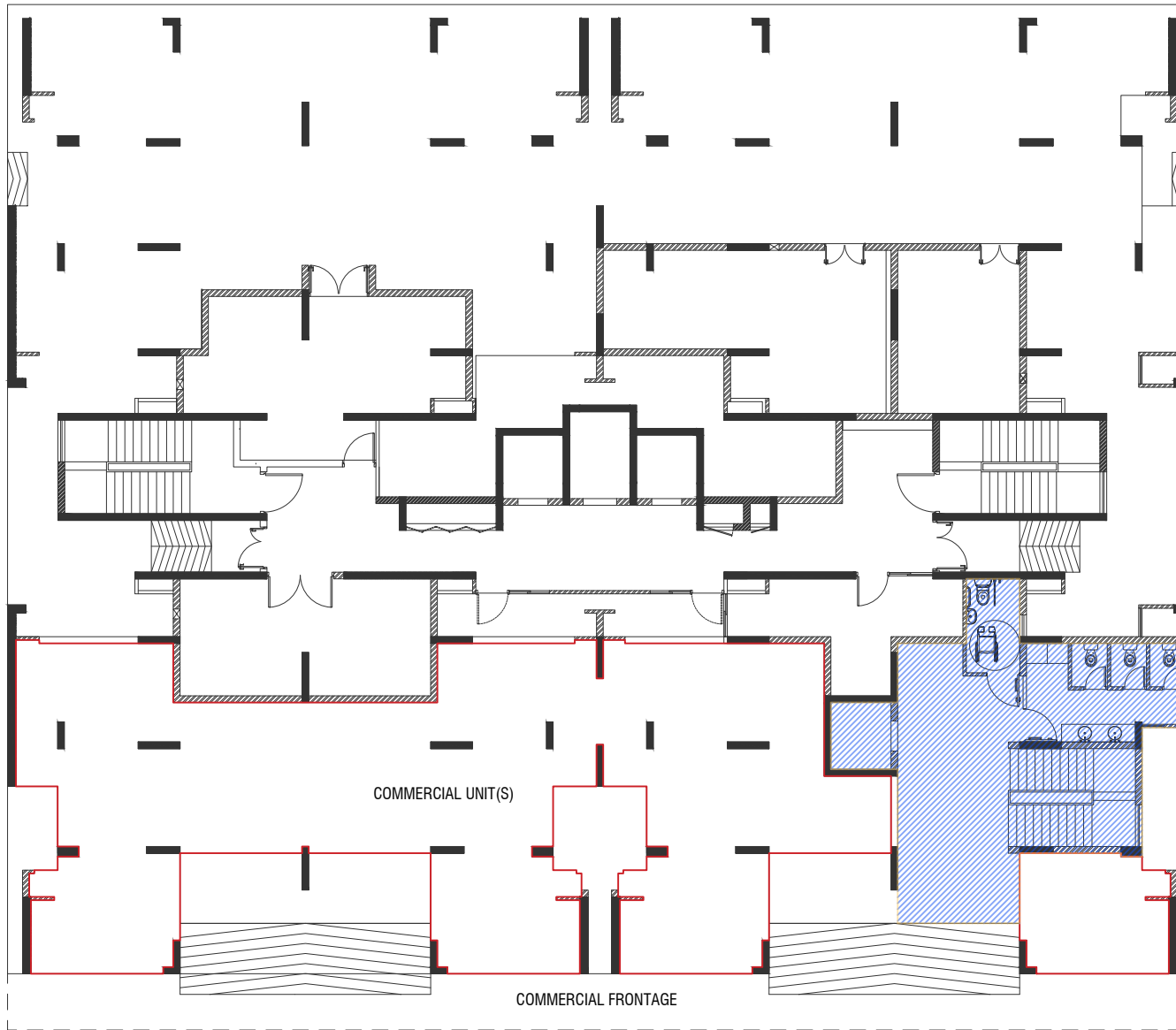

DHOADHI 3BHK GROUND FLOOR PLAN
HULHUMALE' | PHASE 02

- UNIT AREA
- COMMON AREA
- ACCESSORY AREA

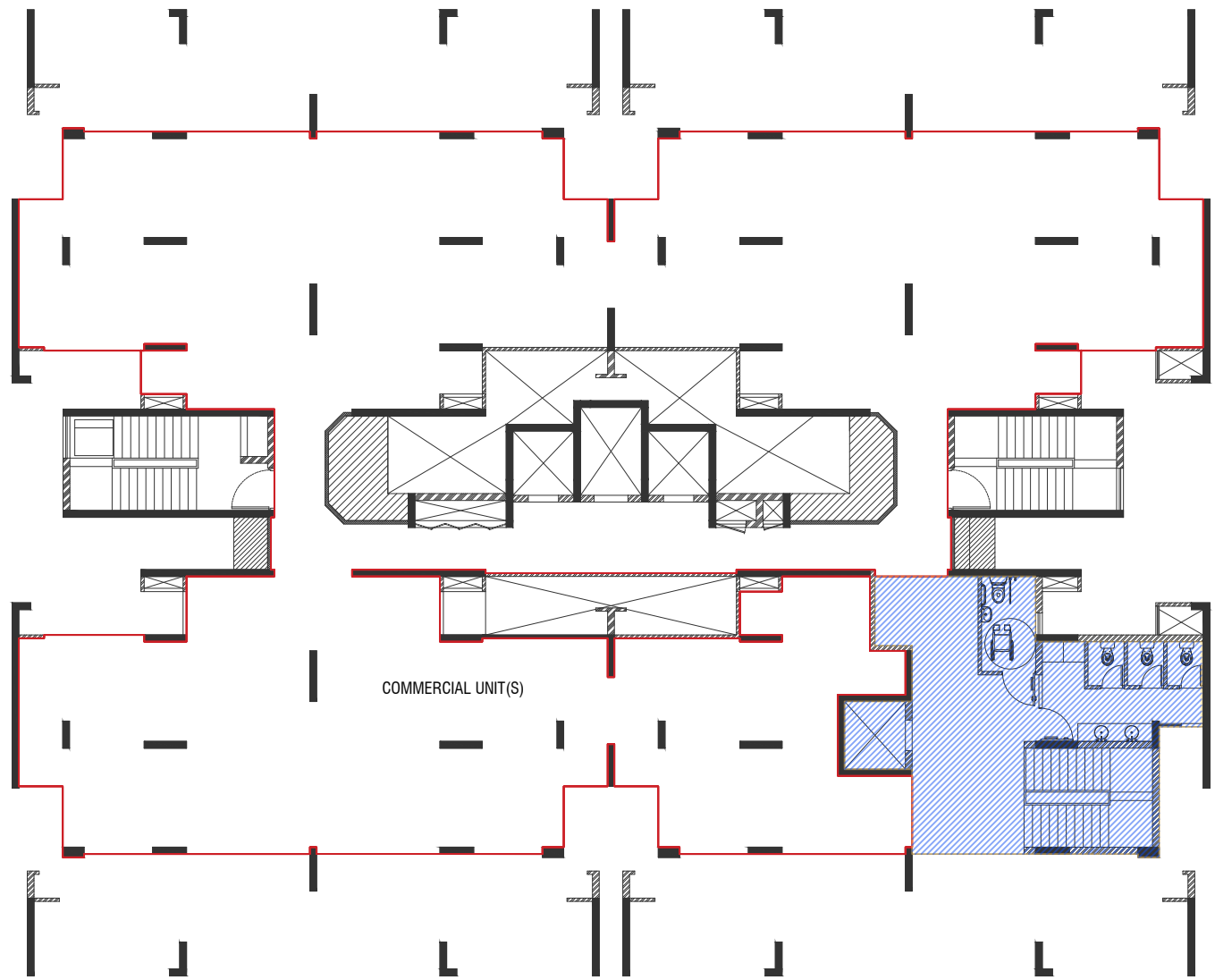

DHOADHI 3BHK FIRST FLOOR PLAN
HULHUMALE' | PHASE 02

-  UNIT AREA
-  COMMON AREA
-  ACCESSORY AREA

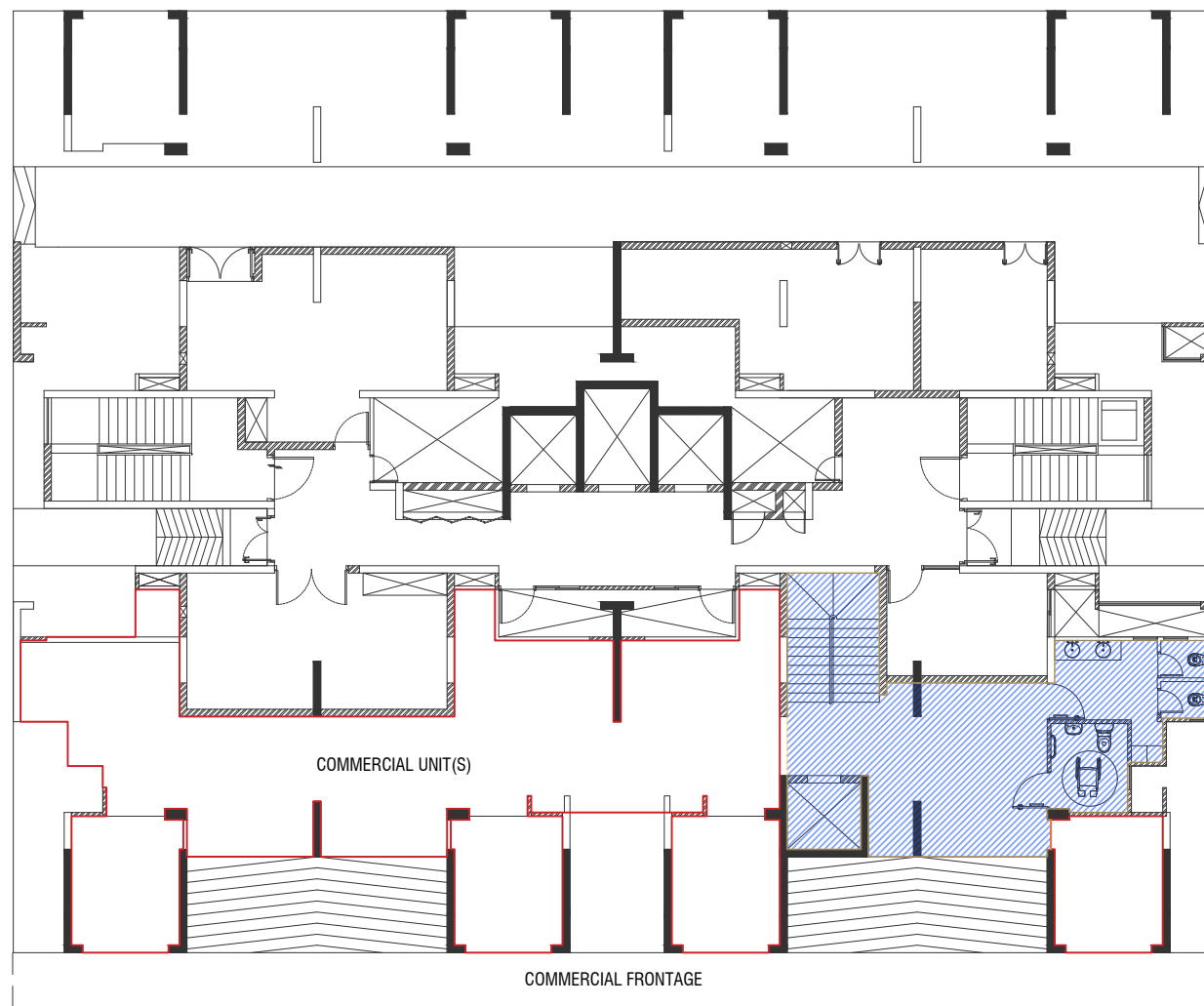

DHOADHI 2BHK GROUND FLOOR PLAN
HULHUMALE' | PHASE 02

- UNIT AREA
- COMMON AREA
- ACCESSORY AREA

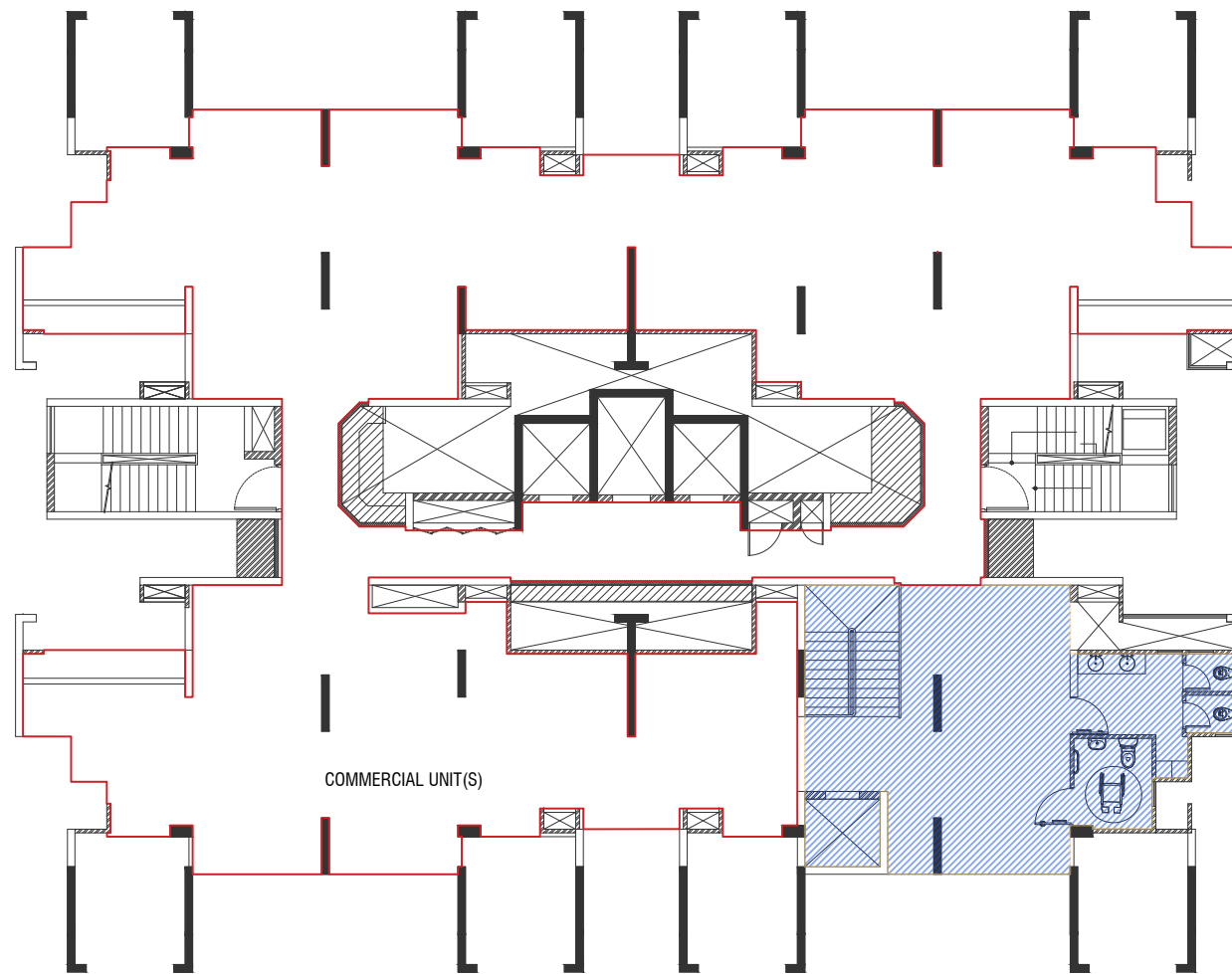

DHOADHI 2BHK FIRST FLOOR PLAN
HULHUMALE' | PHASE 02

-  UNIT AREA
-  COMMON AREA
-  ACCESSORY AREA

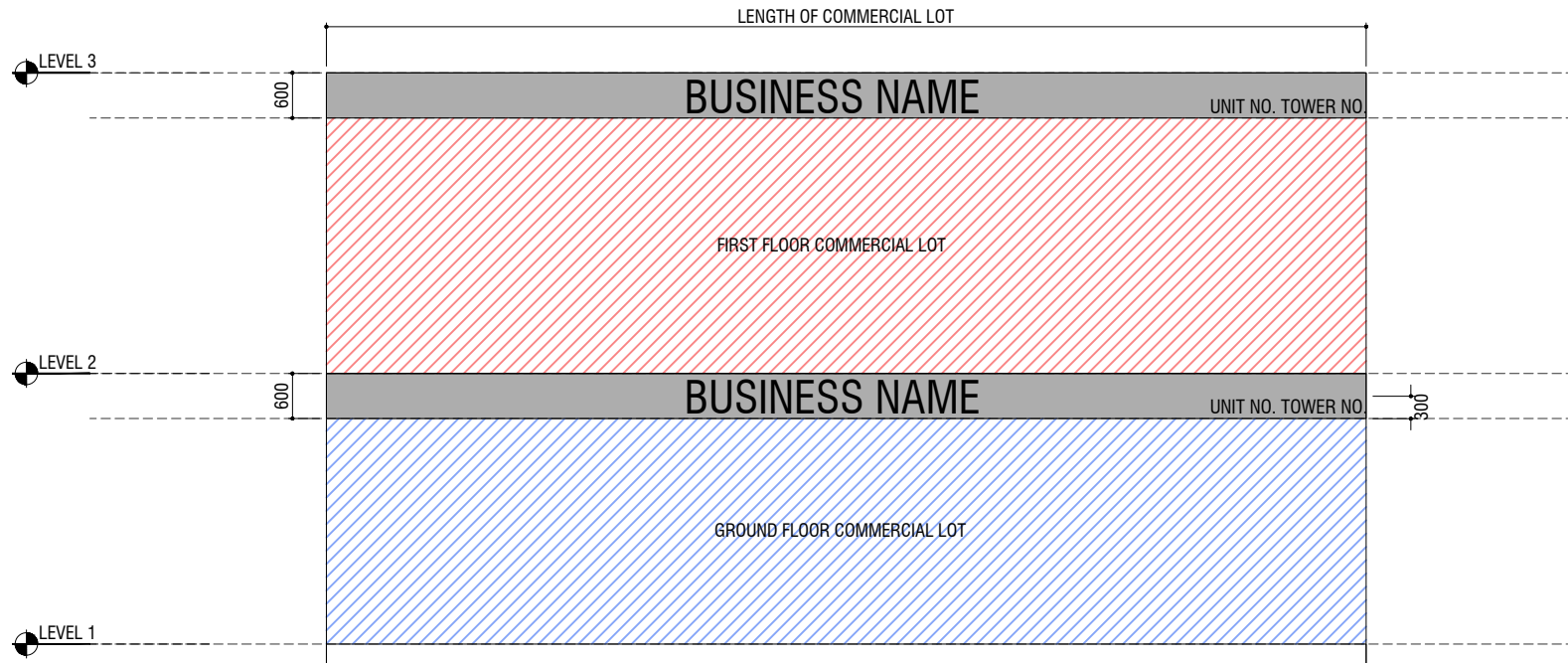

FACADE DETAILS

SCALE 1:100

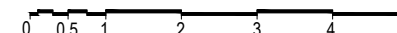

FAHI DHIRIULHUN CORPORATION LTD
POST BUILDING | 6TH FLOOR | 20026
BODUTHAKURUFAANU MAGU | MALE'
TEL: 3313244 | MAIL: planning@fdc.mv

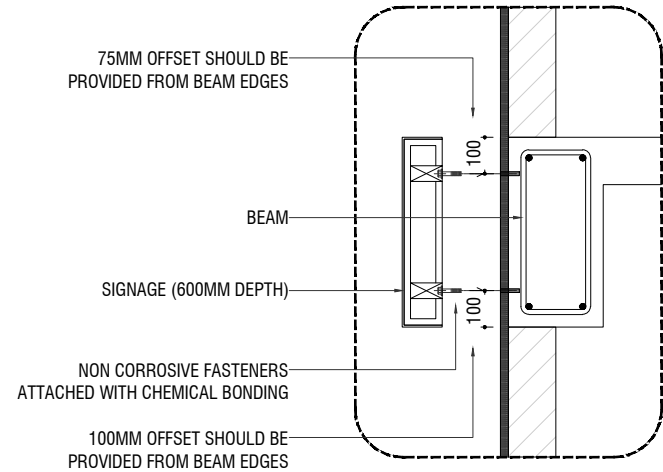
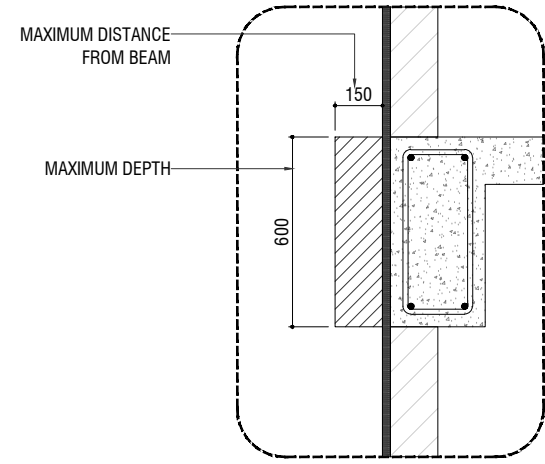
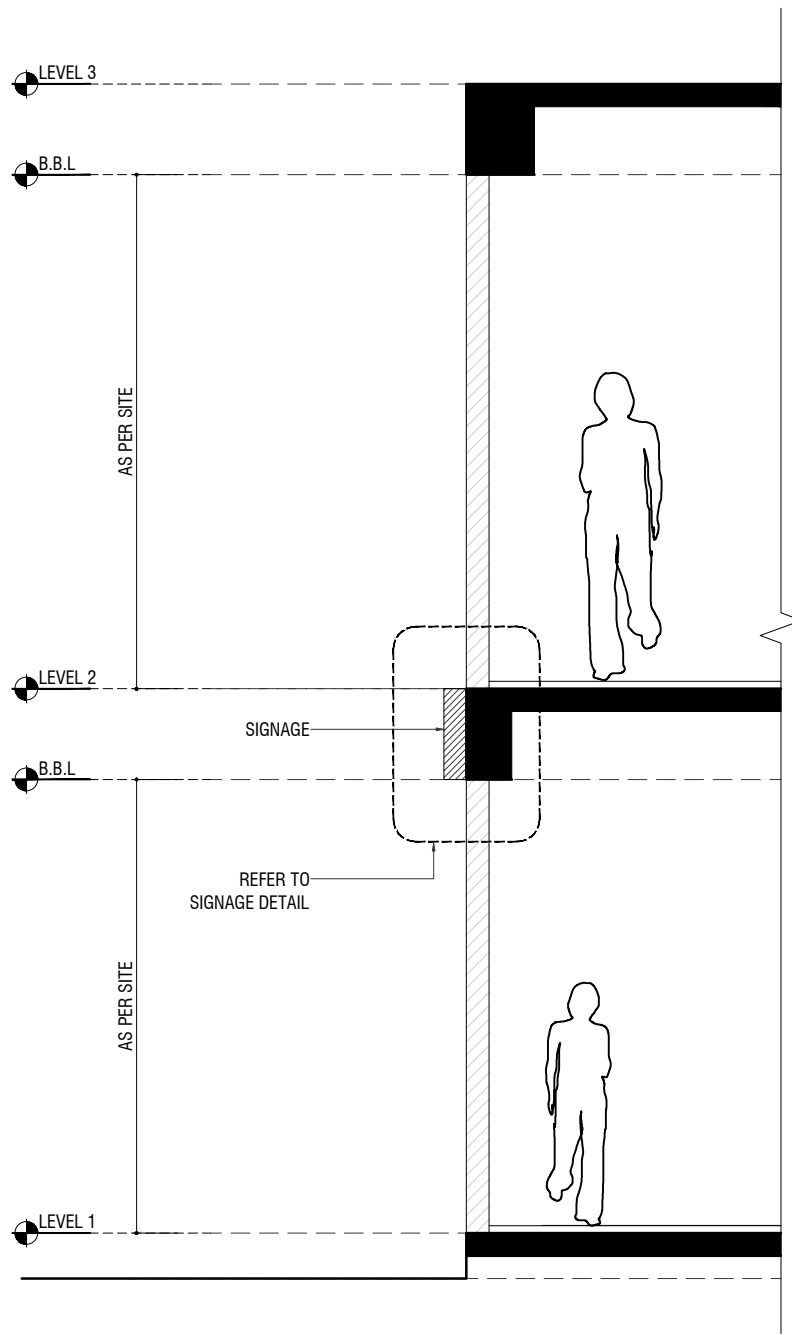

SIGNAGE DETAIL

SIGNAGE INSTALLATION

SCALE 1:50



FAHI DHIRIULHUN CORPORATION LTD
POST BUILDING | 6TH FLOOR | 20026
BODUTHAKURUFAANU MAGU | MALE'
TEL: 3313244 | MAIL: planning@fdc.mv

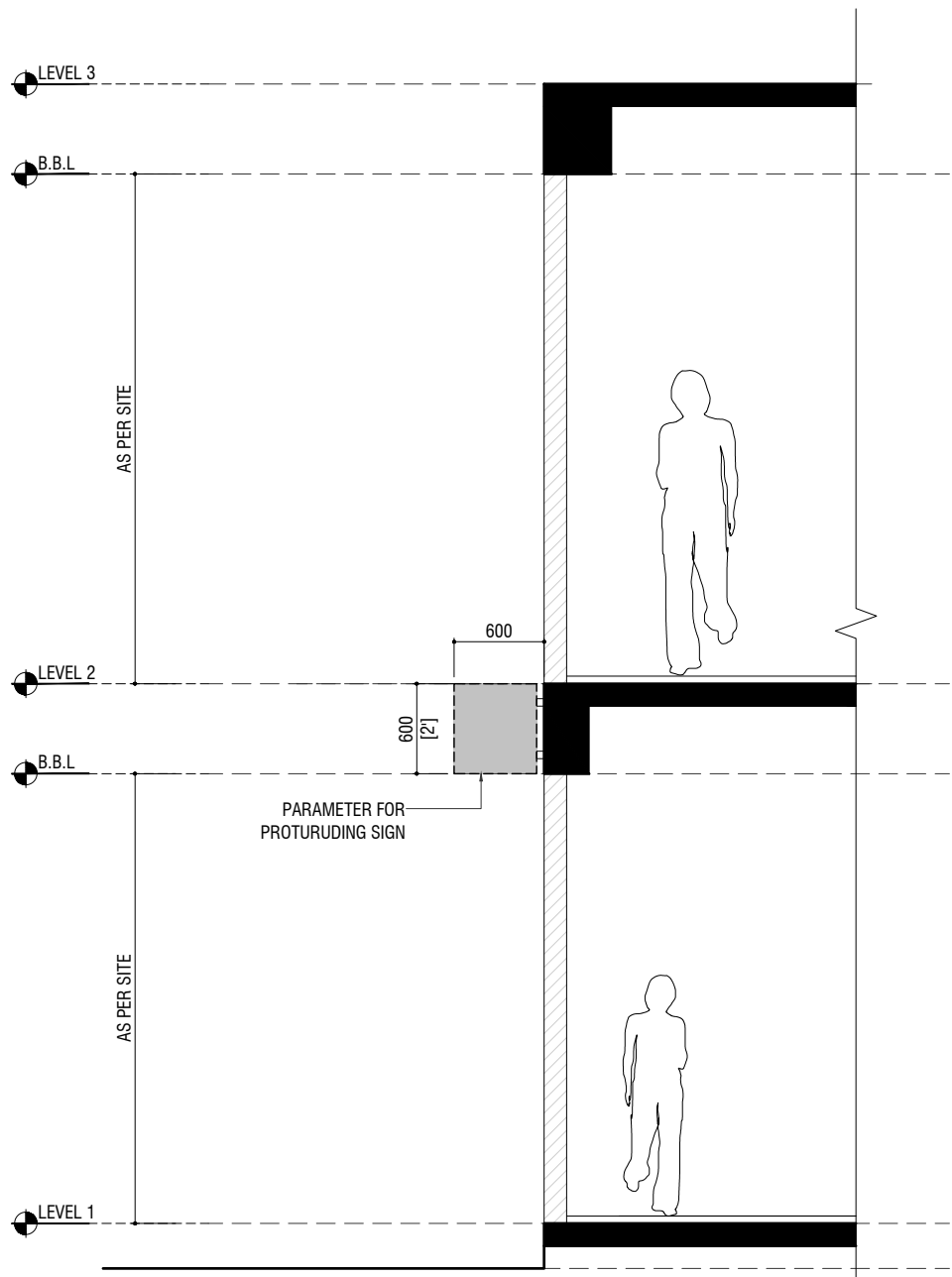

PROTRUDING SIGNAGE

SCALE 1:50



FAHI DHIRIULHUN CORPORATION LTD
POST BUILDING | 6TH FLOOR | 20026
BODUTHAKURUFAANU MAGU | MALE'
TEL: 3313244 | MAIL: planning@fdc.mv

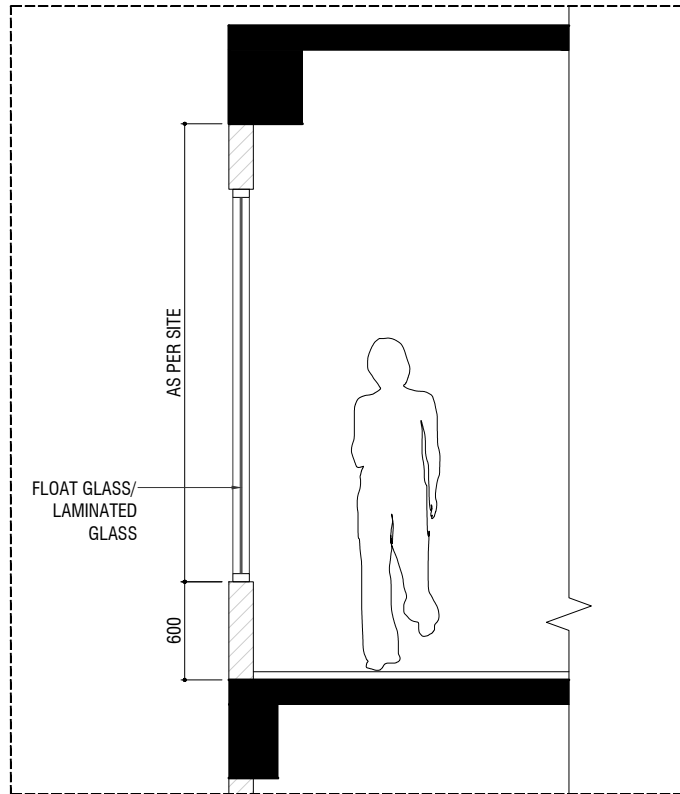

OPTION 1 DETAIL

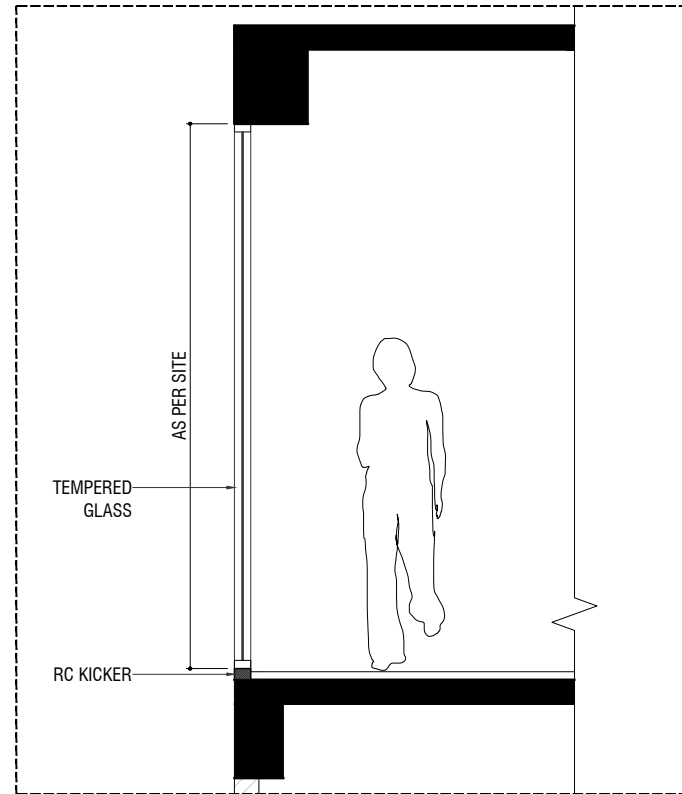

OPTION 2 DETAIL

FACADE DETAILS

SCALE 1:100



FAHI DHIRIULHUN CORPORATION LTD
POST BUILDING | 6TH FLOOR | 20026
BODUTHAKURUFAANU MAGU | MALE'
TEL: 3313244 | MAIL: planning@fdc.mv

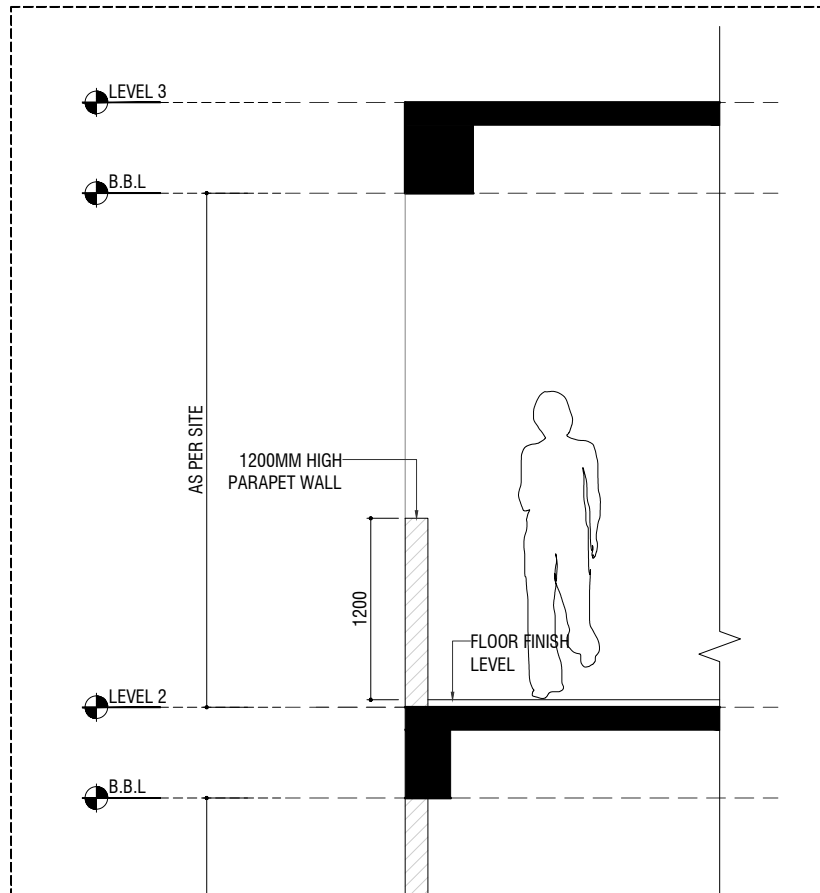

PARAPET WALL

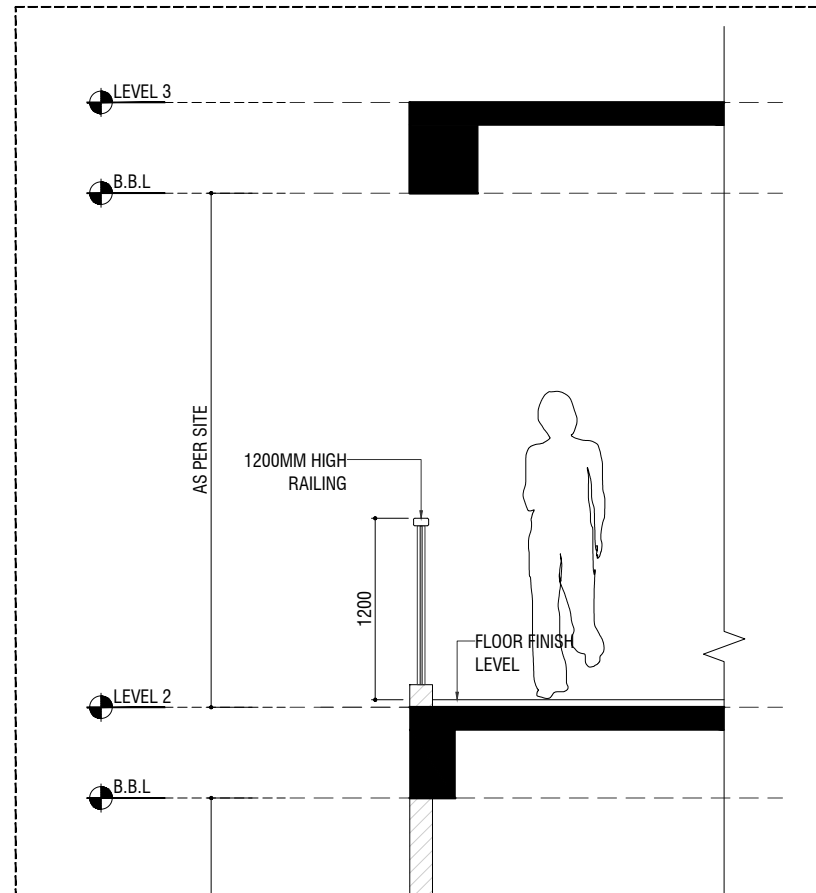

RAILING

PARAPET WALLS AND RAILINGS

SCALE 1:50



FAHI DHIRIULHUN CORPORATION LTD
 POST BUILDING | 6TH FLOOR | 20026
 BODUTHAKURUFAANU MAGU | MALE'
 TEL: 3313244 | MAIL: planning@fdc.mv